

# APERÇU DES MODÈLES 2022 / 23



*cuisine*

TEAM7



# SOMMAIRE

## *matériaux*

bois	3
verre coloré	3
céramique	4
poignées	4

---

## *légende*

rien que la saveur	5
grignoter sur le marché	5
promenade en forêt	6

---

## *conseils de planification*

répartition de façade	7
aperçu des dimensions	8

---

## *corps*

éléments bas	9-11
armoires	12-15
éléments supérieurs	16-17
éléments supérieurs avec lumière	18-19

---

<i>notices</i>	20
----------------	----

## essences de bois

Sauf indication contraire, toutes les surfaces en bois sont traitées à l'huile naturelle.



aulne



hêtre



cœur de hêtre



chêne



chêne sauvage\*



merisier



noyer



noyer sauvage\*



chêne huile blanche

chêne sauvage  
huile blanche\*

## couleurs de verre

brillant ou mat | toutes les surfaces en verre dans la couleur de votre choix (palette NCS, moyennant un supplément)

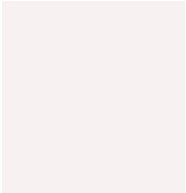
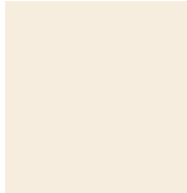
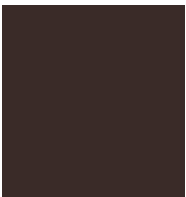
blanc  
(optiwhite)blanc naturel  
(optiwhite)sable  
(optiwhite)galeet  
(optiwhite)taupe  
(optiwhite)boue  
(optiwhite)

brun foncé

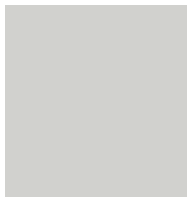
gris clair  
(optiwhite)gris moyen  
(optiwhite)

anthracite

gris graphite  
(optiwhite)

noir

pearl  
(uniquement mat)bronze  
(uniquement mat)acier  
(uniquement mat)

### échantillons de couleur

Le bois est l'un des matériaux naturels les plus beaux, les plus précieux et les plus polyvalents. Chaque pièce est unique. Les différences de couleur dépendent de la structure et de la zone de croissance de l'arbre. Tout comme de l'âge du meuble, car la teinte de la surface varie selon l'environnement ambiant (par ex. lumière du jour). En cas de fabrication d'après un échantillon de couleur, nous nous efforçons toujours de la reproduire le mieux possible. Néanmoins, il y aura toujours de légers écarts car, avec le bois, le cuir, le tissu ou le verre, des couleurs identiques sont impossibles.

\*L'aspect sauvage ne peut être utilisé que sur les façades.

## céramique

utilisation : façades, plans de travail (seulement une sélection des surfaces disponibles sur le marché)



blanc arctique















phedra

ciment

iron grey

noir basalte

## poignées

poignées profilées					
	<b>poignée profilée (GPS)</b> finition inox noir	<b>poignée profilée (GPE)</b> finition inox	<b>poignée profilée (FGS)</b> à fleur de surface finition inox   noir	<b>poignée profilée (FG)</b> à fleur de surface finition inox	
	sans poignée				
		<b>poignée en creux (GFU)</b> finition inox	<b>Servo Drive (AP-SD)</b> électrique <b>ferrure tactile (AP-TD)</b> mécanique		
poignées-barre					
	<b>poignée métallique (MGS)</b> finition inox noir	<b>poignée métallique (MG)</b> finition inox	<b>poignée-barre (SEF)</b> finition inox	<b>poignée-barre (SEN)</b> bois (hêtre, chêne, chêne huile blanche, noyer)	
					
	<b>poignée-barre (GKU)</b> cubique finition inox	<b>poignée-barre (GO)</b> ovale finition inox	<b>poignée (GR)</b> ronde inox	<b>poignée-barre (EF)</b> ronde finition inox	

## légende

Les cuisines TEAM 7 sont aussi individuelles que votre mode de vie. Découvrez notre vaste gamme de cuisines !

### RIEN QUE LA SAVEUR

Ces cuisines aux lignes épurées mettent sur un cachet empreint d'élégance qui associe subtilement la sobriété et la fonctionnalité.



echt.zeit



filigno



black line



k7

### GRIGNOTER SUR LE MARCHÉ

Les cuisines d'une diversité presque infinie permettent chaque planification, quels que soient la taille et le style.



linee



cera line



linee



l1

## PROMENADE EN FORÊT

Découvrir le bois véritable, utilisé généreusement, avec tous les sens est également au cœur de ces cuisines.



## informations sur la planification

répartition façades / hauteur de corps : h 67,0 cm et h 80,4 cm

### exemple de répartition façades

U\_80L2A2\_  
hauteur de trame : 13,4 cm  
écartement de façade : 0,4 cm

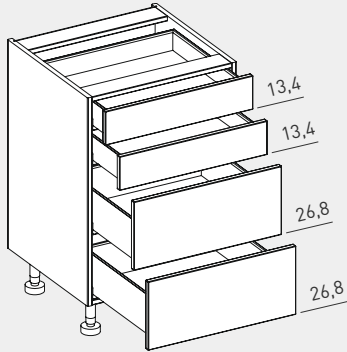

Nos croquis symbolisés sont toujours cotés, y c. joint en profilé.

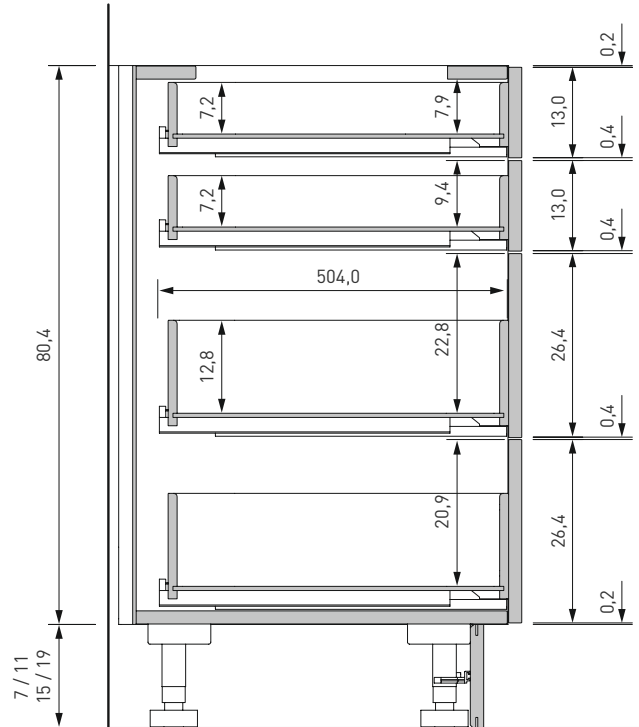

hauteur de corps élément bas 67,0 cm

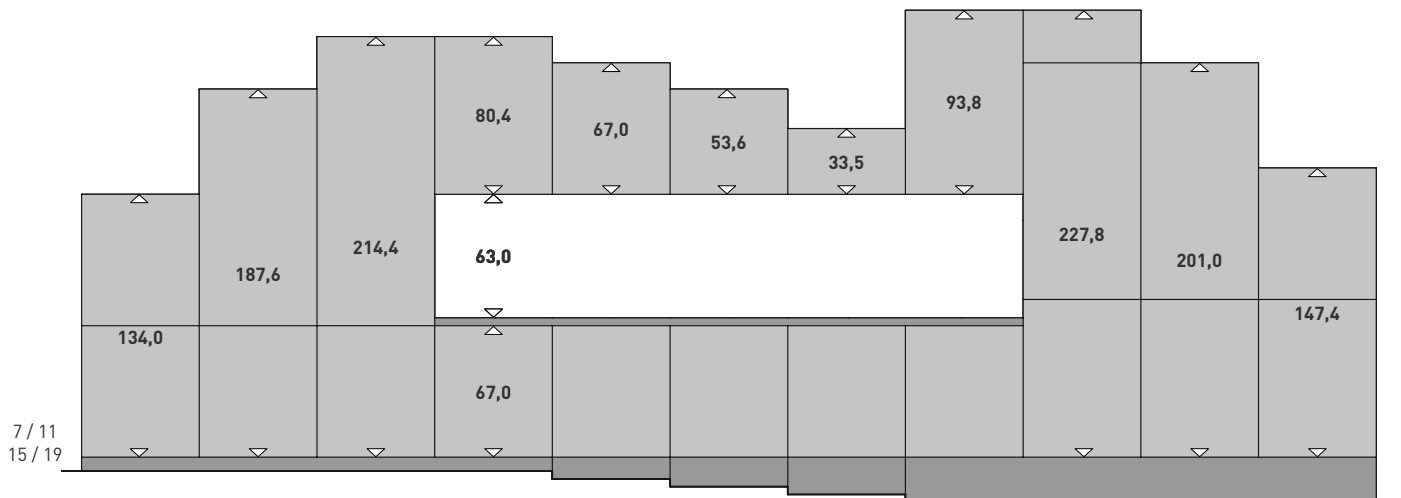

hauteur du corps de l'élément bas 80,4 cm

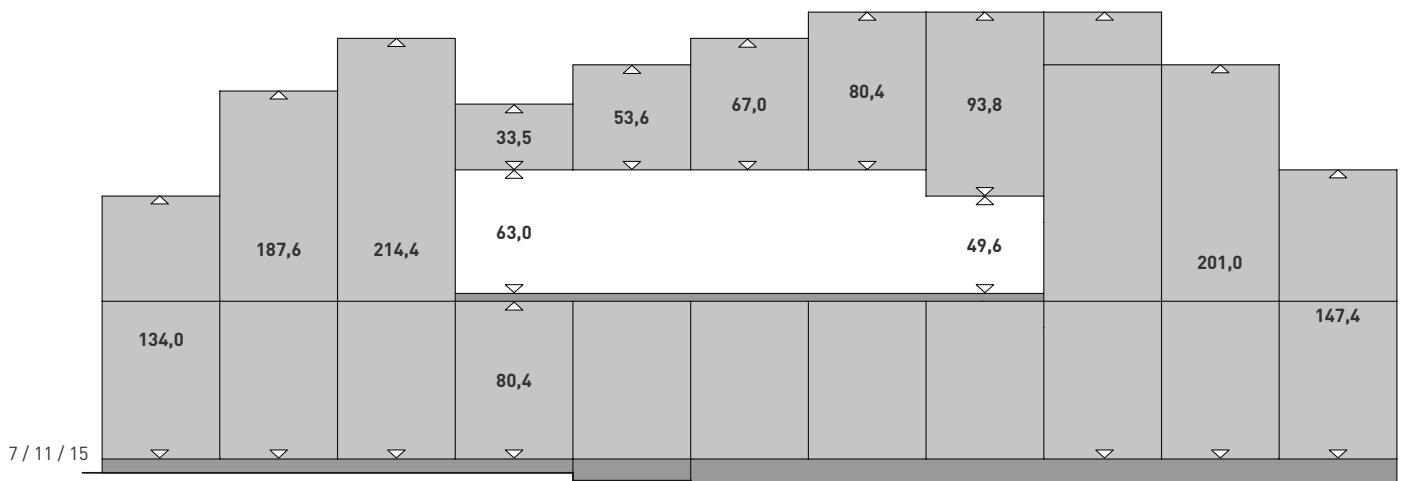

# conseils de planification



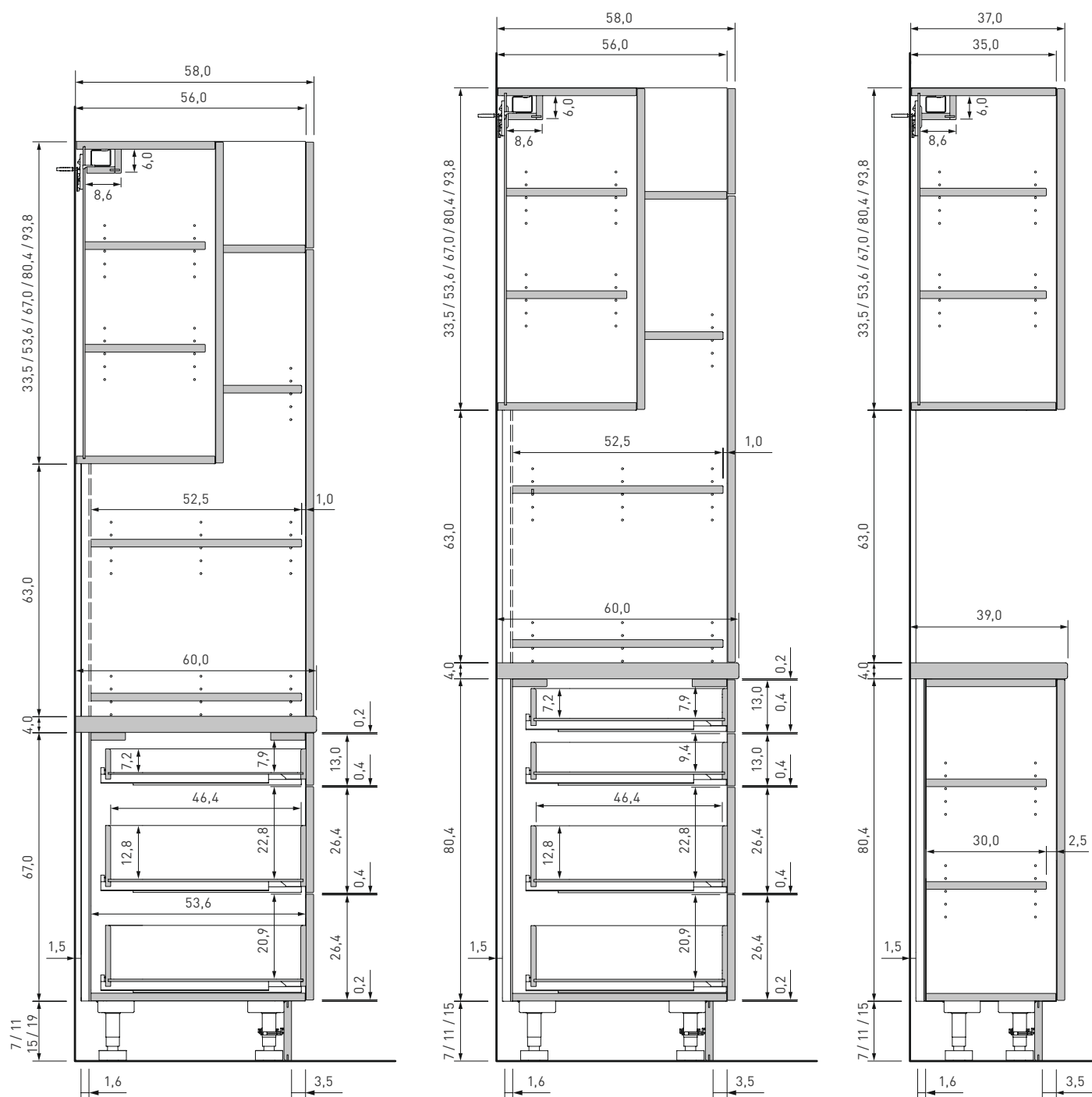







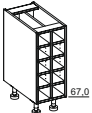
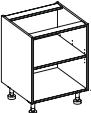

aperçu des dimensions

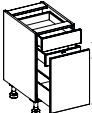
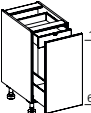
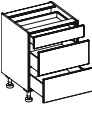
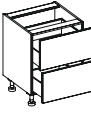

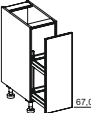
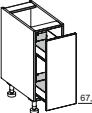



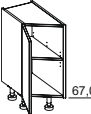
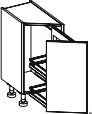
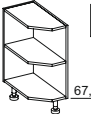

éléments bas | linee | echt.zeit | loft | rondo





hauteur : 67,0 cm

 30	<b>UF3067</b>	 67.0	<b>U_67</b>	 67.0	<b>U_67T_</b>	 13.4 53.6	<b>U_67TG_</b>	 13.4 53.6	<b>U_67LT_</b>					
15/20/30/40/45/50/60/80/90/100/120														
 30/40/45/50/60	<b>U_67LAI_</b>	13.4 11.0 53.6	 30/40/45/50/60	<b>U_67AI_</b>	11.0 67.0	 30/40/45/50/60/80/90/100/120	<b>U_67LA2_</b>	13.4 26.8 26.8	 30/40/45/50/60/80/90/100/120	<b>U_67A2_</b>	33.5 33.5	 30/40/45/50/60/80/90/100/120	<b>U_67L3A_</b>	13.4 13.4 26.8
30/40/45/50/60/80/90/100/120														
 30/45/60	<b>U_67TI3_</b>	11.0 17.0 17.0 67.0	 15/20/30/40/45	<b>U_67AR_</b>	67.0	 15/20/30	<b>U_67AP_</b>	67.0	 15/20/30/40/45/50/60/80/90/100/120	<b>U_67TB_</b>	var.	 30/45/60	<b>U_67TI3_</b>	11.0 17.0 17.0 var.
15/20/30/40/45														
 160/180/200/240	<b>U_67ST_</b>	67.0	 15/30	<b>UR_67T_</b>	67.0	 15/30	<b>UR3067AR</b>	67.0	 30	<b>UARE3067</b>	67.0	 30	<b>UARR3067</b>	67.0
15/30														
 60/80/90/100/120	<b>UOR_80</b>	67.0	<b>UOR_80S</b>	<b>UOR_80L</b>	<b>UOR_80LS</b>									



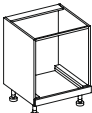

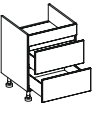



éléments d'angle

 90/105	<b>UED_67T_</b>	67.0	 90	<b>UE9067K_</b>	67.0	 110	<b>UEG9067T_</b>	67.0	 110/115/125	<b>UEG_67LR_</b>	67.0	 110/115/125	<b>UEG_67LP_</b>	67.0
--	-----------------	------	---	-----------------	------	--	------------------	------	---	------------------	------	--	------------------	------

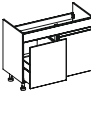
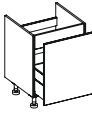
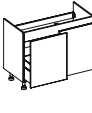
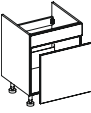
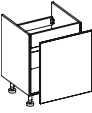
éléments pour four





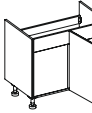





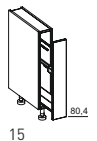
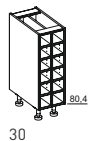

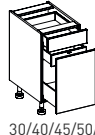
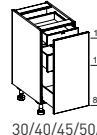
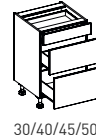

 60	<b>UH6067B_</b>	var.	 60/80/90/100/120	<b>UK1_67LA2_</b>	13.4 26.8 26.8	 60/80/90/100/120	<b>UK2_67BA2_</b>	13.4 26.8 26.8	 90/100/120	<b>US_67A2_</b>	13.4 26.8 26.8	 90/100/120	<b>MSNIK2_</b>	
--	-----------------	------	---	-------------------	----------------------	---	-------------------	----------------------	--	-----------------	----------------------	---	----------------	--

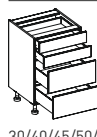
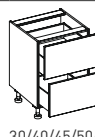
sous-évier

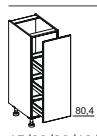
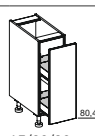

 45/50/60/80/90/100/120	<b>US_67BT_</b>	13.4 53.6	 45/50/60/80/90/100/120	<b>US_67T_</b>	67.0	 45/50/60/90	<b>US_67BA_</b>	13.4 53.6	 80/90/100/120	<b>US_67BAA_</b>	13.4 53.6	 45/50/60/90	<b>US_67A_</b>	67.0
45/50/60/80/90/100/120														
 80/90/100/120	<b>US_67AA_</b>	67.0	 45/60	<b>US_67B_</b>	13.4 53.6	 90/105	<b>US_67_</b>	67.0	 60	<b>MSNI60</b>		 45/60	<b>MSBL_</b>	
45/60														
 40/45/50/60/90	<b>MSNIK_</b>		 90/105	<b>USD_67BT_</b>	13.4 53.6	 90/105	<b>USD_67T_</b>	67.0	 110	<b>MSUSD</b>		 110	<b>USEG9067T_</b>	67.0
90/105														

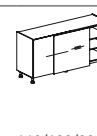
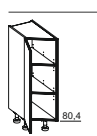
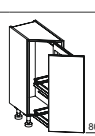
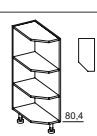
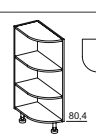
éléments bas | linee | echt.zeit | loft | rondo

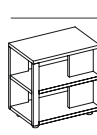
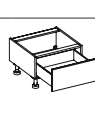
hauteur : 80,4 cm

 U1580H_ 15	 UF3080 30	 U_80 15/20/30/40/45/50/60/80/90/100/120	 U_80T_ 15/20/30/40/45/50/60/80/90/100/120	 U_80TG_ 15/20/30/40/45/50/60/80/90/100/120
 U_80LT_ 30/40/45/50/60/80/90/100/120	 U_80LAI_ 30/40/45/50/60	 U_80AI2_ 30/40/45/50/60	 U_80LAA_ 30/40/45/50/60/80/90/100/120	 U_80LA2_ 30/40/45/50/60/80/90/100/120
 U_80L2A2_ 30/40/45/50/60/80/90/100/120	 U_80A2_ 30/40/45/50/60/80/90/100/120	 U_80A3_ 30/40/45/50/60/80/90/100/120	 U_80L4A_ 30/40/45/50/60/80/90/100/120	 U_80TI4_ 30/45/60
 U_80AR_ 15/20/30/40/45	 U_80AP_ 15/20/30	 U_80TB_ 15/20/30/40/45/50/60/80/90/100/120	 U_80TBI4_ 30/45/60	 U_80ST_ 160/180/200/240
 UR_80T_ 15/30	 UR3080AR_ 15/30	 UARE3080 30	 UARR3080 30	 UOR_80 UOR_80S UOR_80L UOR_80LS 60/80/90/100/120
 UOFR_80_ 60/80/90	 U_26A_ 45/50/60/80/90/100/120			

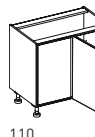
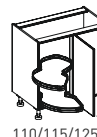
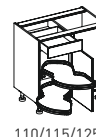
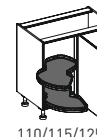
éléments d'angle

 UED_80T_ 90/105	 UEG9080T_ 110	 UEG_80LR_ 110/115/125	 UEG_80LLR_ 110/115/125	 UEG_80LP_ 110/115/125
 UEG_80LLP_ 110/115/125	 UE9080K_ 90			

éléments bas linee | echt.zeit | loft | rondo

éléments pour four

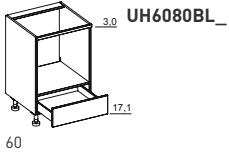
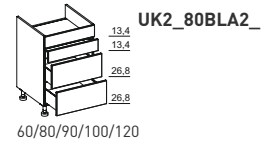
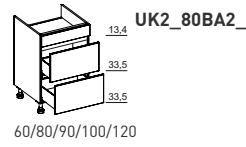
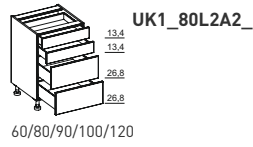
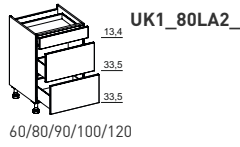
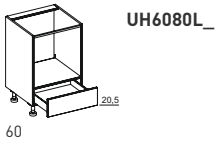



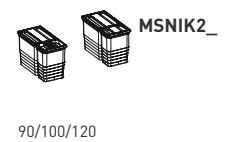
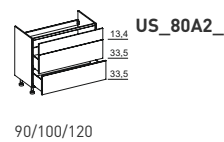
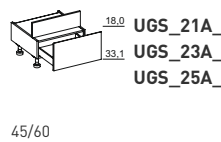
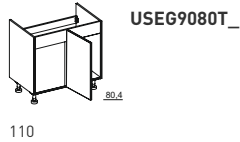
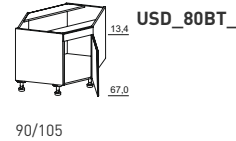
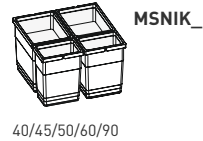
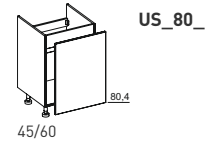
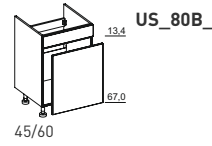
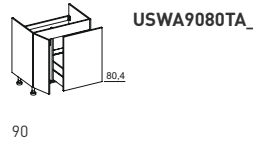
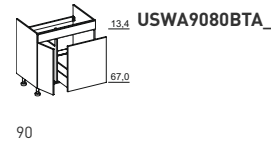
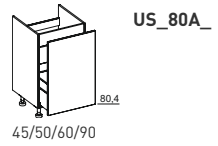
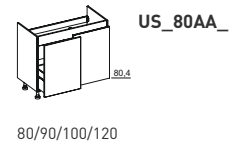
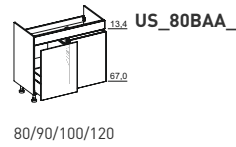
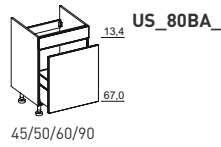
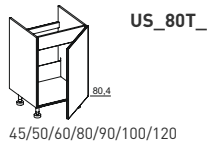
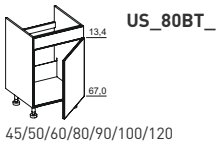



















sous-évier

























armoires | linee | echt.zeit | loft | rondo

hauteur : 134,0 cm





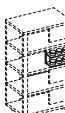

 30/40/45/50/60/80/90/100/120	 30/40/45/50/60/80/90/100/120	 30/45/60	 30/45	 30/45
 45/60	 30	 30	 90/100	 90/100
 120	 60	 60	 60	 60
 60	 60	 60	 60	 10/20
 60/80/90	 60/80/90			

hauteur : 147,4 cm



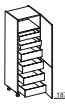
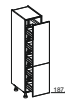
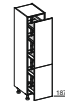
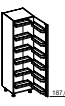
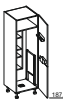
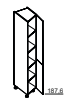
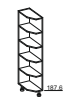
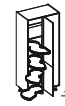
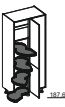

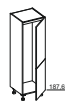

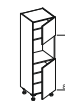
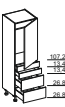
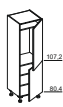
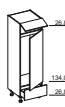
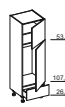
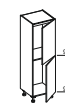
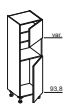
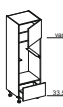
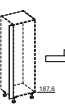
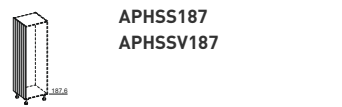
 30/40/45/50/60/80/90/100/120	 30/40/45/50/60/80/90/100/120	 30/45/60	 30/45	 30/45
 45/60	 30	 30	 90/100	 90/100
 120	 60	 60	 60	 60
 60	 60	 60	 60	 10/20
 60/80/90	 60/80/90			

armoires | linee | echt.zeit | loft | rondo

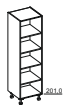
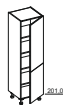
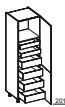
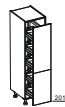
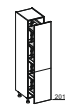
hauteur : 187,6 cm

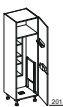
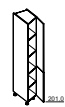
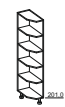
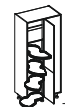
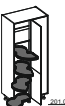

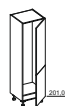
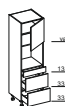
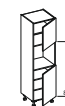

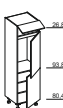
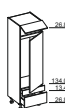
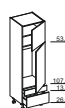
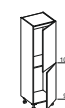
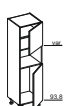
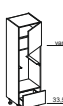
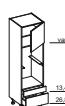
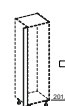
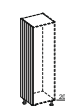



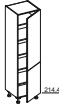
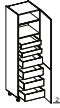
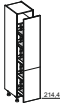
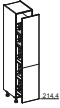
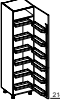
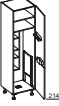
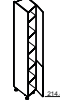
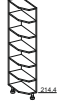

 30/40/45/50/60/80/90/100/120	 30/40/45/50/60/80/90/100/120	 30/45/60	 30/45	 30/45
 60	 60	 30	 30	 90/100
 90/100	 120	 60	 60	 60
 60	 60	 60	 60	 60
 60	 60	 10/20		

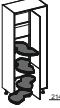
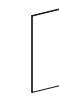
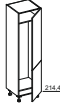
hauteur : 201,0 cm

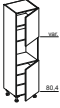
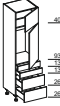

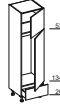
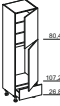

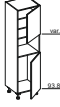
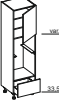







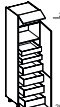
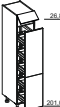
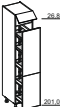

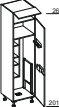
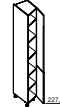

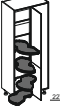
 30/40/45/50/60/80/90/100/120	 30/40/45/50/60/80/90/100/120	 30/45/60	 30/45	 30/45
 60	 60	 30	 30	 90/100
 90/100	 120	 60	 60	 60
 60	 60	 60	 60	 60
 60	 60	 60	 10/20	

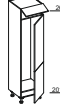
armoires | linee | echt.zeit | loft | rondo

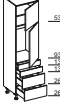
hauteur : 214,4 cm

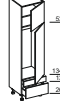
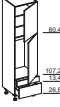
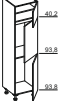
 30/40/45/50/60/80/90/100/120	<b>H_214</b>	 30/40/45/50/60/80/90/100/120	<b>H_214T_</b>	 30/45/60	<b>H_214TI6_</b>	 30/45	<b>H_214AR_</b>	 30/45	<b>H_214AP_</b>
 60	<b>H_60214TP_</b>	 60	<b>HB60214T_</b>	 30	<b>HR30214T_</b>	 30	<b>HARE30214 HARR30214</b>	 90/100	<b>HE_214LR_</b>
 90/100	<b>HE_214LP_</b>	 120	<b>FBWM_</b>	 60	<b>HG214179_</b>	 60	<b>HG214BTLA2_</b>	 60	<b>HG214BT2_</b>
 60	<b>HG21488TL2A2_</b>	 60	<b>HG21488T2_</b>	 60	<b>HG214123TA_</b>	 60	<b>HG214102TA_</b>	 60	<b>HG2148888K_</b>
 60	<b>HG2148839T_</b>	 60	<b>HG214G2TA_</b>	 10/20	<b>HSB_214_</b>	 214,4	<b>APHSS214 APHSSV214</b>		

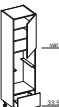
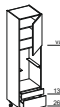
hauteur : 227,8 cm

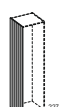
 30/40/45/50/60/80/90/100/120	<b>H_227</b>	 30/40/45/50/60/80/90/100/120	<b>H_227KT_</b>	 30/45/60	<b>H_227KTi6_</b>	 30/45	<b>H_227KAR_</b>	 30/45	<b>H_227KAP_</b>
 60	<b>H60227TP_</b>	 60	<b>HB60227T_</b>	 30	<b>H30227T_</b>	 30	<b>HARE30227 HARR30227</b>	 90/100	<b>HE_227LR_</b>
 90/100	<b>HE_227LP_</b>	 120	<b>FBWM_</b>	 60	<b>HG227179K_</b>	 60	<b>HG227BTLA2_</b>	 60	<b>HG227BT2_</b>
 60	<b>HG22788TL2A2_</b>	 60	<b>HG22788T2_</b>	 60	<b>HG227123TLA_</b>	 60	<b>HG227102TLA_</b>	 60	<b>HG2278888T_</b>
 60	<b>HG2278839T_</b>	 60	<b>HG227G2TA_</b>	 60	<b>HG227G2TLA_</b>	 10/20	<b>HSB_227_</b>	 227,8	<b>APHSS227 APHSSV227</b>

armoires linee | echt.zeit | loft | rondo

armoire à portes coulissantes pivotantes



HDS\_18713\_

69.3/138.6

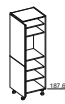

HGDS18760\_

69.3

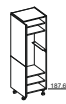

HGDS187G2\_

69.3



WSDS\_187  
WWDS\_187

1.2/1.9/2.5



HDS\_20113\_

69.3/138.6



HGDS20160\_

69.3

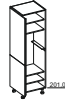

HGDS201G2\_

69.3



WSDS\_201  
WWDS\_201

1.2/1.9/2.5



HDS\_21413\_

69.3/138.6

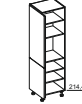

HGDS21460\_

69.3



HGDS214G2\_

69.3

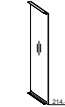

WSDS\_214  
WWDS\_214

1.2/1.9/2.5

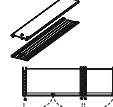

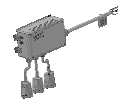

DSC\_







AADS





éléments supérieurs linee | echt.zeit | loft | rondo





hauteur : 33,5 cm

 <b>O_33</b>	 <b>O_33K_</b>	 <b>O_33KIAL</b>
15/20/30/40/45/50/60/80/90/100/120	30/40/45/50/60/80/90/100/120	30/40/45/50/60/80/90/100/120





hauteur : 53,6 cm





 <b>O_53</b>	 <b>O_53T_</b>	 <b>O_53KIAL</b>	 <b>O_53S_</b>	 <b>OA_53SA_</b>
15/20/30/40/45/50/60/80/90/100/120	15/20/30/40/45/50/60/80/90/100/120	60/80/90/100/120	60/90	





 <b>OFL6053T_</b>	 <b>OFL_53T_</b>	 <b>O_53M</b>	 <b>OARE3053</b>	 <b>OARR3053</b>
60	90/100/120	50/60	30	30

 <b>OEG_53T_</b>	 <b>OEG_53T_</b>	 <b>OE_53</b>	 <b>OE_53T_</b>	 <b>OED6553T_</b>
80/90	110/115/125	60/65/90	60/65/90	65

hauteur : 67,0 cm





 <b>O_67</b>	 <b>O_67T_</b>	 <b>O_67F_</b>	 <b>OA_67FA_</b>	 <b>OFL6067T_</b>
15/20/30/40/45/50/60/80/90/100/120	15/20/30/40/45/50/60/80/90/100/120	60/80/90/100/120	60/90	60





 <b>OFL_67T_</b>	 <b>OFL_67F_</b>	 <b>O_67M</b>	 <b>O_67MK_</b>	 <b>OARE3067</b>
90/100/120	90/100/120	50/60	50/60	30





 <b>OARR3067</b>	 <b>OEG_67T_</b>	 <b>OEG_67T_</b>	 <b>OE_67</b>	 <b>OE_67T_</b>
30	80/90	110/115/125	60/65/90	60/65/90

 <b>OED6567T_</b>
65

hauteur : 80,4 cm

 <b>O_80</b>	 <b>O_80T_</b>	 <b>O_80F_</b>	 <b>OA_80FA_</b>	 <b>OFL6080T_</b>
15/20/30/40/45/50/60/80/90/100/120	15/20/30/40/45/50/60/80/90/100/120	60/80/90/100/120	60/90	60

 <b>OFL_80T_</b>	 <b>OFL_80F_</b>	 <b>O_80M</b>	 <b>O_80MT_</b>	 <b>OEG_80T_</b>
90/100/120	90/100/120	50/60	50/60	80/90

 <b>OEG_80T_</b>	 <b>OE_80</b>	 <b>OE_80T_</b>	 <b>OED6580T_</b>	 <b>OARE3080</b>
110/115/125	60/65/90	60/65/90	65	30



éléments supérieurs | linee | echt.zeit | loft | rondo



OARR3080

30

hauteur : 93,8 cm



O\_93

15/20/30/40/45/50/60/80/90/100/120



O\_93T\_

15/20/30/40/45/50/60/80/90/100/120



OFL6093T\_

60

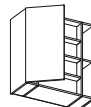

OFL\_93T\_

90/100/120



O\_93M

50/60



O\_93MT\_

50/60

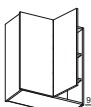

OEG\_93T\_

80/90

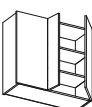

OEG\_93T\_

110/115/125

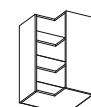

OE\_93

60/65/90



OE\_93T\_

60/65/90



OED6593T\_

65

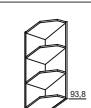

OARE3093

30

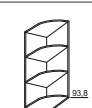

OARR3093

30

éléments à poser

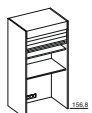

A\_103RO  
A\_116RO  
A\_130RO  
A\_143RO  
A\_156RO

60/80/90/100/120

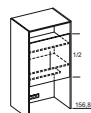

A\_103VS\_  
A\_116VS\_  
A\_130VS\_  
A\_143VS\_  
A\_156VS\_

60/80/90/100/120



A\_1034RO  
A\_1164RO  
A\_1304RO  
A\_1434RO  
A\_1564RO

60/80/90/100/120

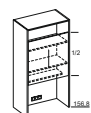

A\_1034VS\_  
A\_1164VS\_  
A\_1304VS\_  
A\_1434VS\_  
A\_1564VS\_

60/80/90/100/120

## information éléments supérieurs avec lumière

Il est possible d'équiper les meubles d'un éclairage, voir tableau ci-dessous.  
Deux températures de couleur à choix : WW...blanc chaud ou KW...blanc froid.



Température de couleur :  
si aucune information n'est donnée à ce sujet,  
WW...blanc chaud sera automatiquement livré.

### équiper les meubles avec des accessoires.

#### exemple :

Équiper un élément supérieur ouvert avec respectivement un spot LED carré dans les panneaux supérieur et inférieur, un passe-câble et un kit transfo avec interrupteur à capteur.

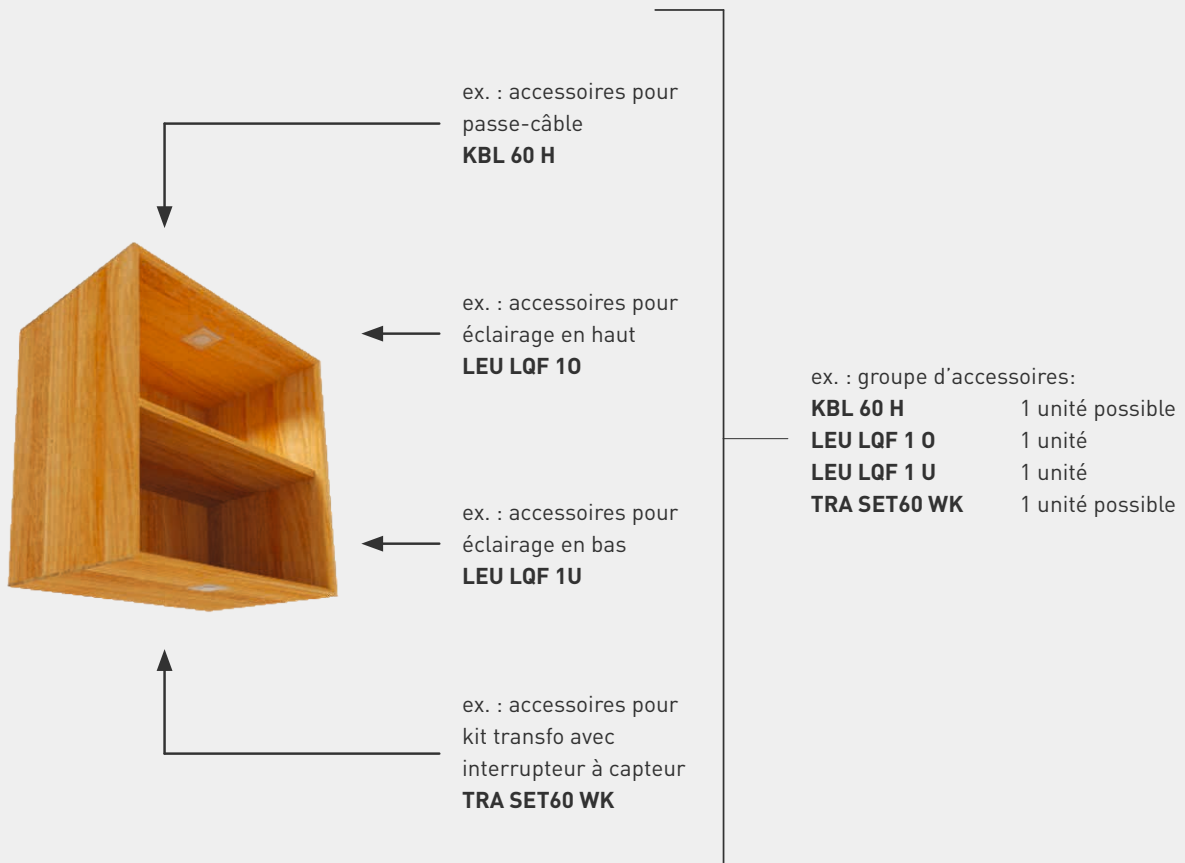

## information éléments supérieurs avec lumière

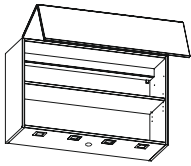
éléments supérieurs avec LED	
 <p>température de couleur :                      3200K ○WW...blanc chaud                      5000K ○KW...blanc froid</p>	
largeur de corps	nombre de lampes LED / puissance
30	1 lampe LED / 3 W
40	1 lampe LED / 3 W
45	1 lampe LED / 3 W
50	1 lampe LED / 3 W
60	2 lampes LED / 6 W
80	2 lampes LED / 6 W
90	3 lampes LED / 9 W
100	3 lampes LED / 9 W
120	4 lampes LED / 12 W

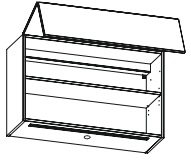
éléments supérieurs avec profilé LED	
 <p>température de couleur :                      3200K ○WW...blanc chaud                      4000K ○KW...blanc froid</p>	
largeur de corps	longueur profilés LED / puissance
—	—
—	—
—	—
—	—
50	profilé LED 40 cm / 4,5 W
60	profilé LED 40 cm / 4,5 W
80	profilé LED 60 cm / 7 W
90	profilé LED 60 cm / 7 W
100	profilé LED 90 cm / 10,5 W
120	profilé LED 90 cm / 10,5 W



### interrupteur à capteur :

toujours au centre  
(invisible de l'extérieur).

allumer / éteindre et régler l'intensité  
lumineuse sans contact



## éclairage



spot LED rond orientable  
finition inox | noir

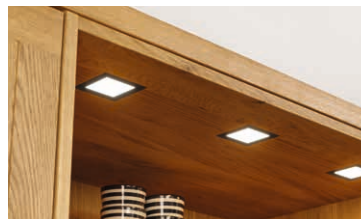

spot LED carré fixe  
noir mat



spot LED carré fixe  
finition inox



pont lumineux  
couleur entre 2 700 et 6 500 Kelvin



profilé lumineux LED à encastrer  
finition inox | noir



lampe à suspension

*notices*

---





Des informations importantes concernant les caractéristiques spécifiques au matériau des meubles en bois naturel de TEAM 7 sont disponibles à la rubrique Certificat de qualité et de Service à l'adresse [www.team7-home.com/certificat-garantie-service](http://www.team7-home.com/certificat-garantie-service)



TEAM 7 Natürlich Wohnen GmbH

téléphone +43 7752 977-700 | e-mail [info@team7.at](mailto:info@team7.at) | [www.team7-home.com](http://www.team7-home.com)

Autriche | 4910 Ried / Innkreis | Braunauer Straße 26

Suisse / Italie | 5643 Sins / AG | Tschampani 30

# TEAM 7