



planning folder *cubus pure wall units*

TEAM7



CPWW 1

BK, EI, KB, NB



CPWW 2

ER, BK, EI, NB



CPWW 4

BK, EI, KB, NB



CPWW 10

ER, EI, KB, NB



CPWW 11

EIWI, KB, NB, EI-W



CPWW 15

BK, EI, KB, NB



CPWW 16

BK, EI, KB, NB



CPWW 17

ER, BK, EI, NB



CPWW 18

BK, EI, KB, NB

summary *cubus pure wall units*

TEAM7



CPWW 19

ER, BK, EI, NB



CPWW 20

BK, EI, KB, NBWI



CPWW 22

ER, KB, NB, EI-W



CPWW 23

BK, KB, NB, EI-W



CPWW 24

BK, EIVE, NB, EI-W



CPWW 24 A

ER, EI, KB, NB



CPWW 25

BK, EI, KB, NB



CPWW 25 A

ER, BK, NB, EI-W



CPWW 26

ER, BK, EI-W, NB

summary *cubus pure wall units*

TEAM7



CPWW 27

ER, BK, EI-W, NB



CPWW 28

BK, EI, KB, NB



CPWW 30

ER, BK, EI, KB



CPWW 31

BK, EI-W, KB, NB



cubus pure wall unit, CPWW 1

TEAM7



cubus pure wall unit, CPWW 1

TEAM7

TEAM7

cubus pure wall unit

CPWW 1

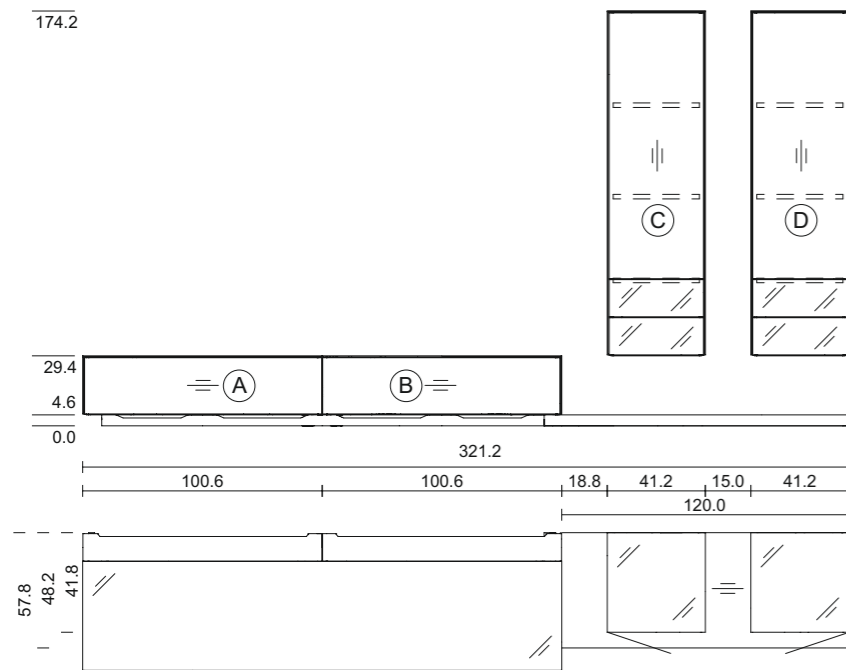

summary



wood type: walnut
glass: white

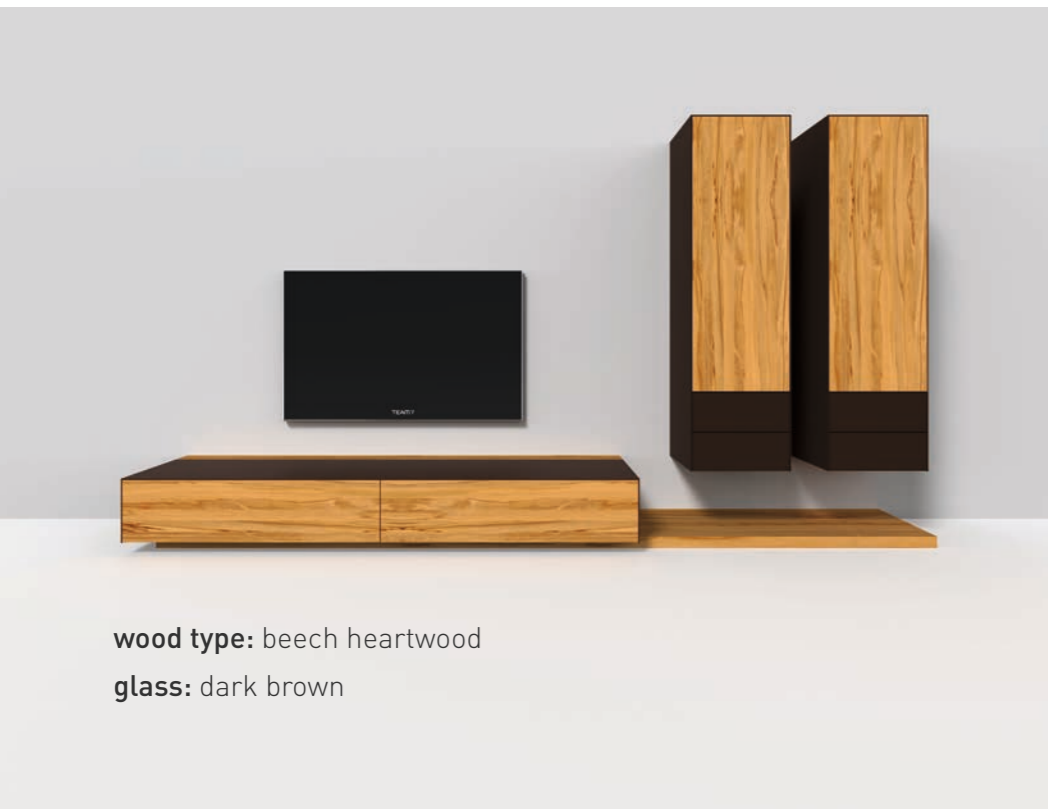

wood type: beech heartwood
glass: dark brown

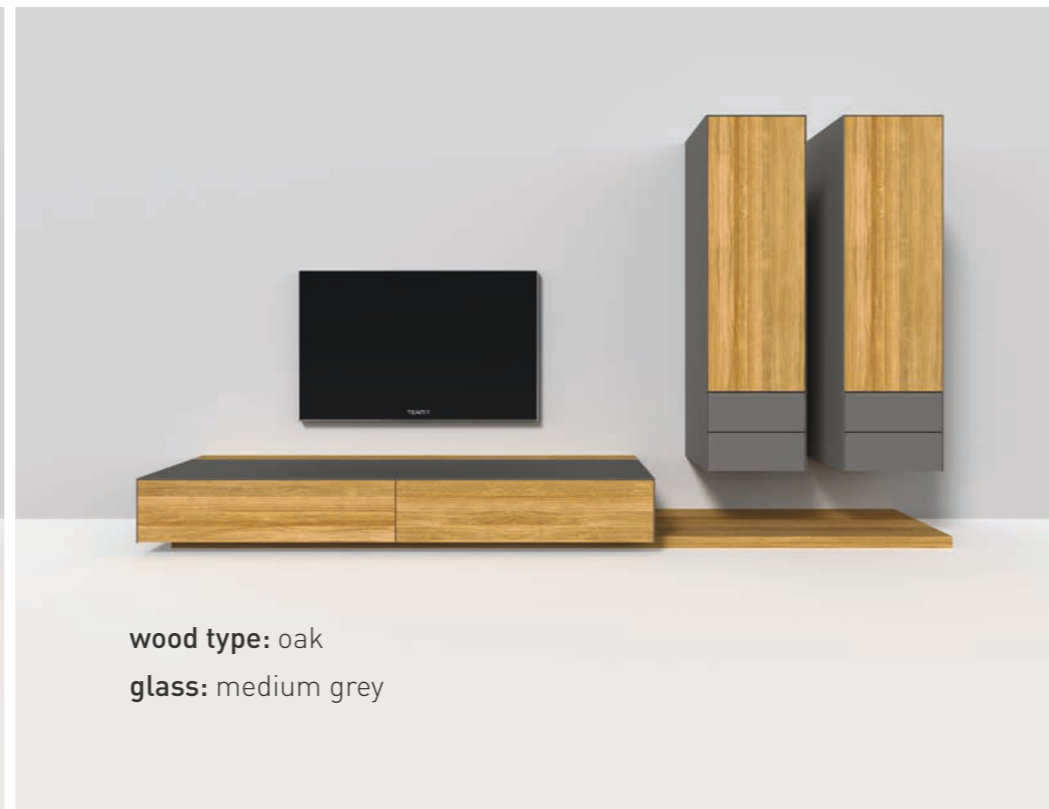

wood type: oak
glass: medium grey

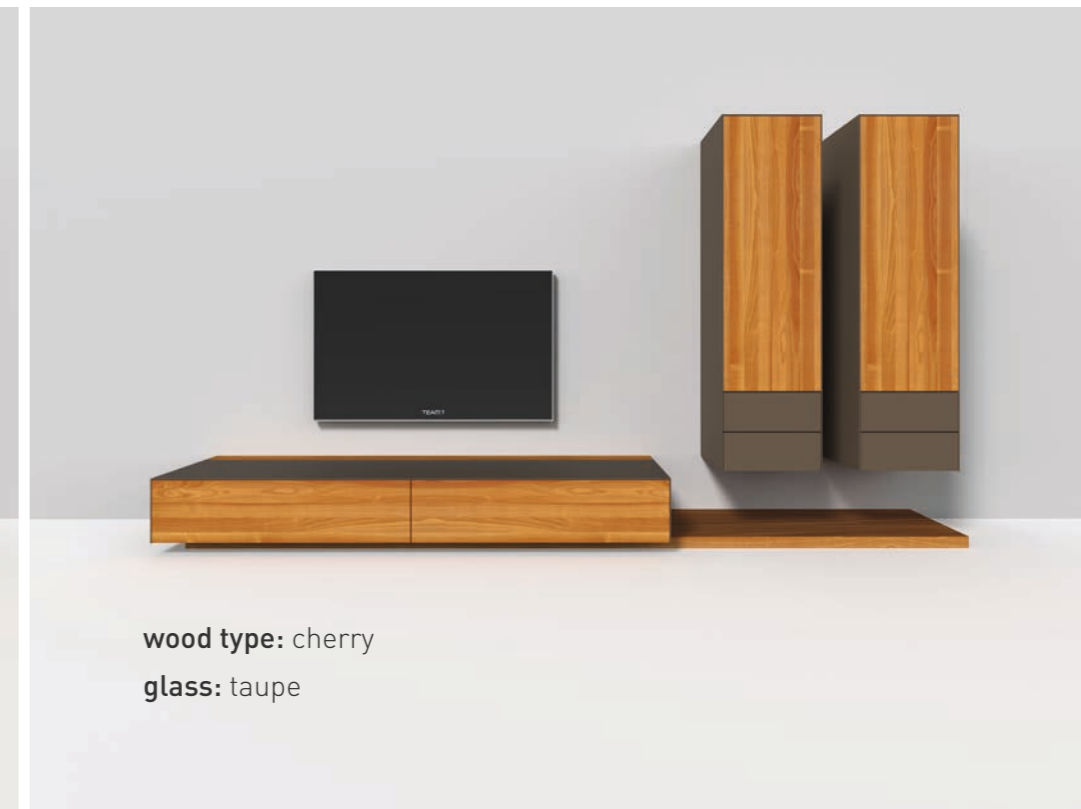

wood type: cherry
glass: taupe



cubus pure wall unit, CPWW 2

TEAM7



cubus pure wall unit, CPWW 2

TEAM7

TEAM7

cubus pure wall unit

CPWW 2

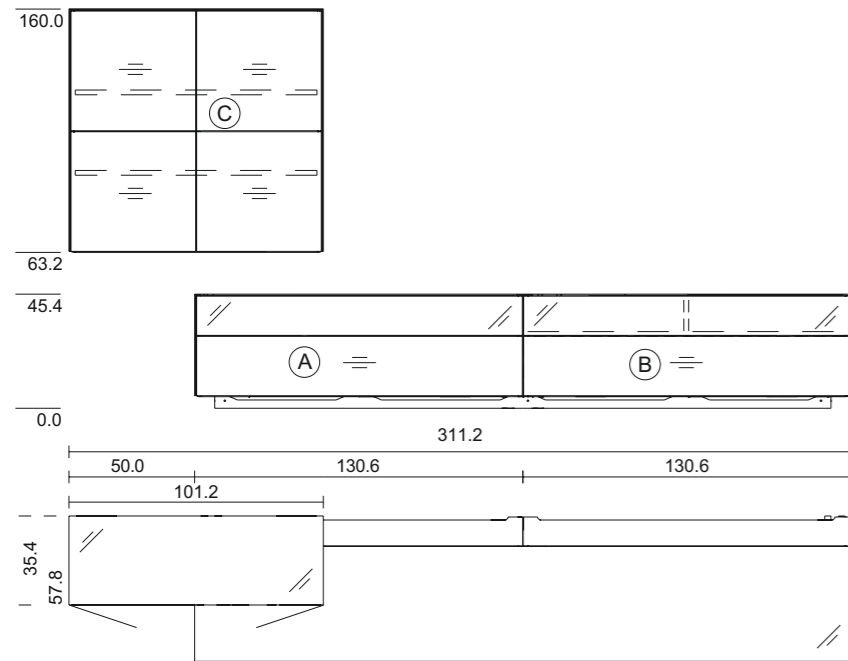

summary



wood type: oak
glass: taupe

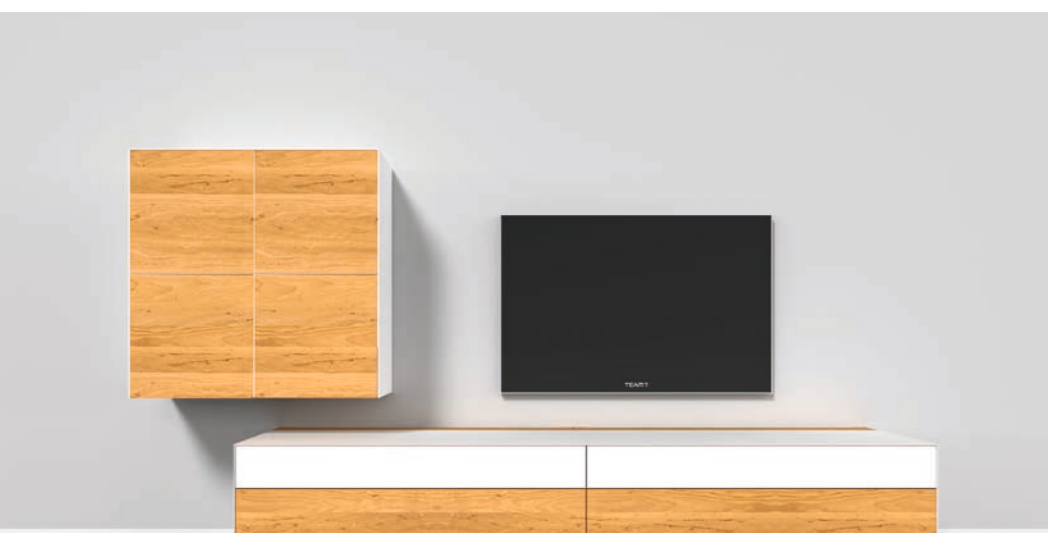

wood type: alder
glass: white



wood type: beech heartwood
glass: sludge



wood type: walnut
glass: pebble



cubus pure wall unit, CPWW 4

TEAM7



cubus pure wall unit, CPWW 4

TEAM7

TEAM7

summary

cubus pure wall unit

CPWW 4

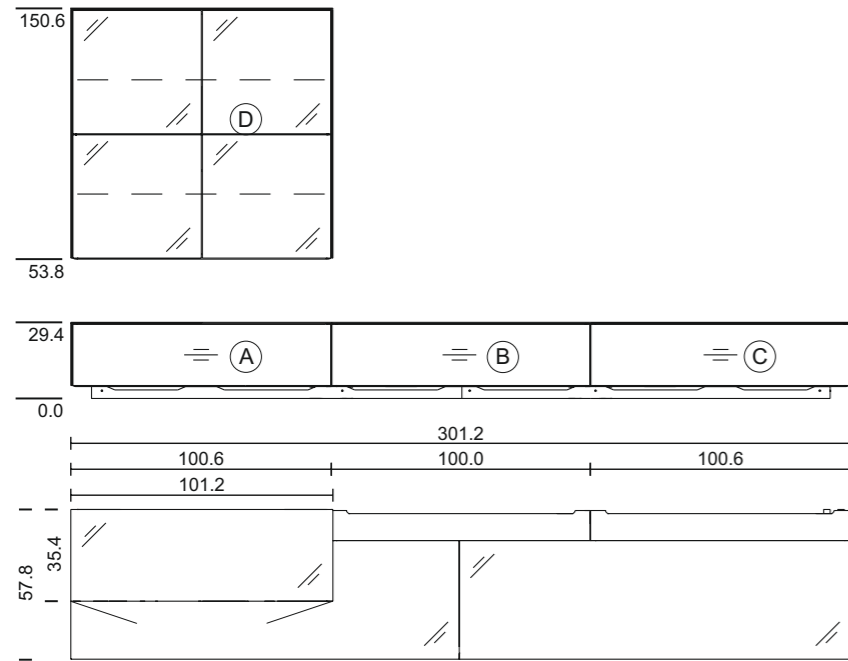

wood type: beech heartwood
glass: white

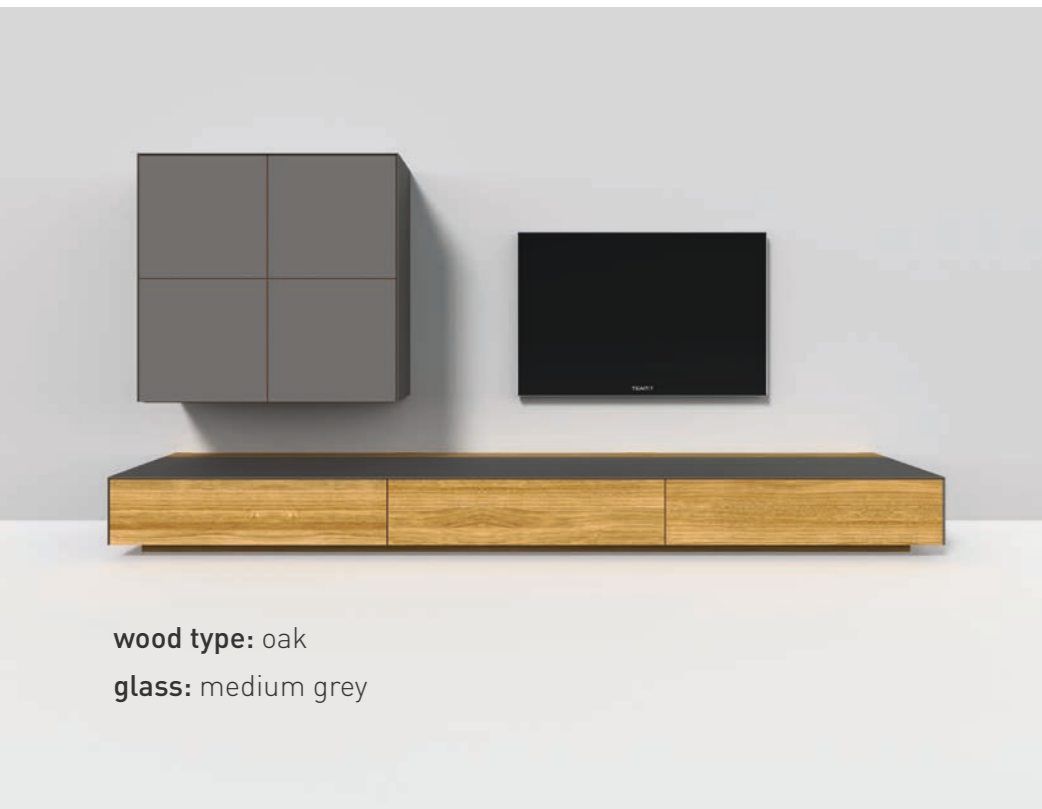

wood type: oak
glass: medium grey



wood type: cherry
glass: anthracite

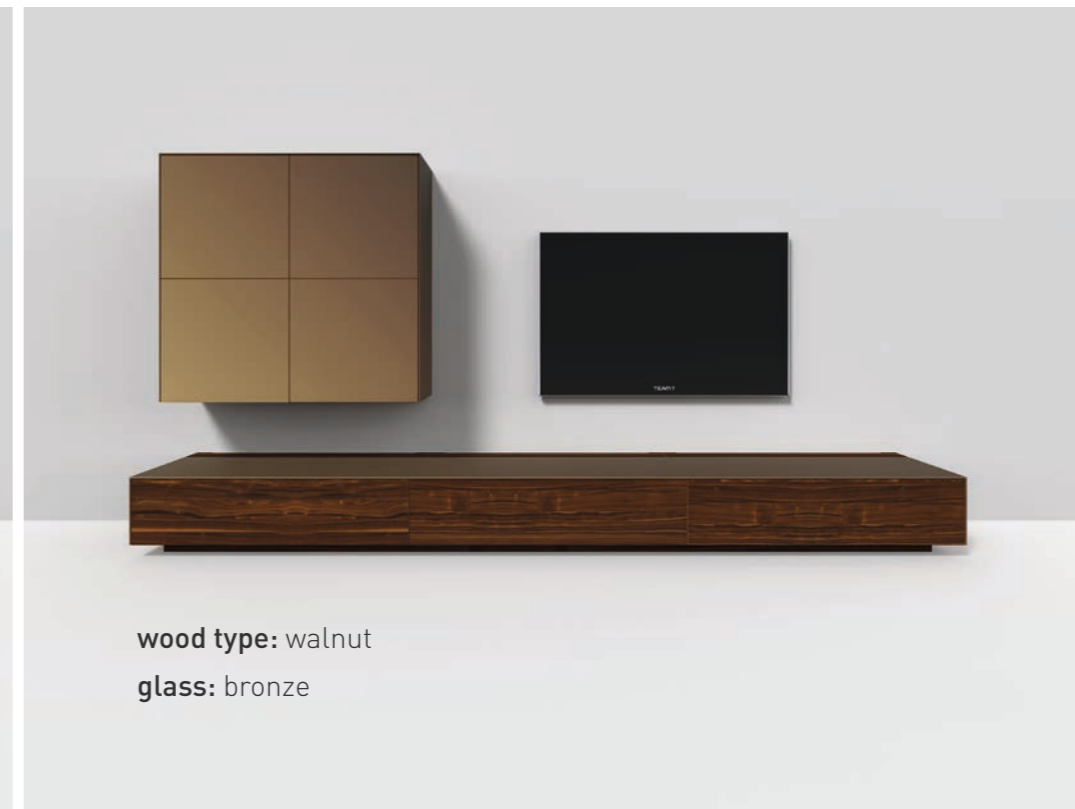

wood type: walnut
glass: bronze



cubus pure wall unit, CPWW 10

TEAM7



cubus pure wall unit, CPWW 10

TEAM7

TEAM7

cubus pure wall unit

CPWW 10

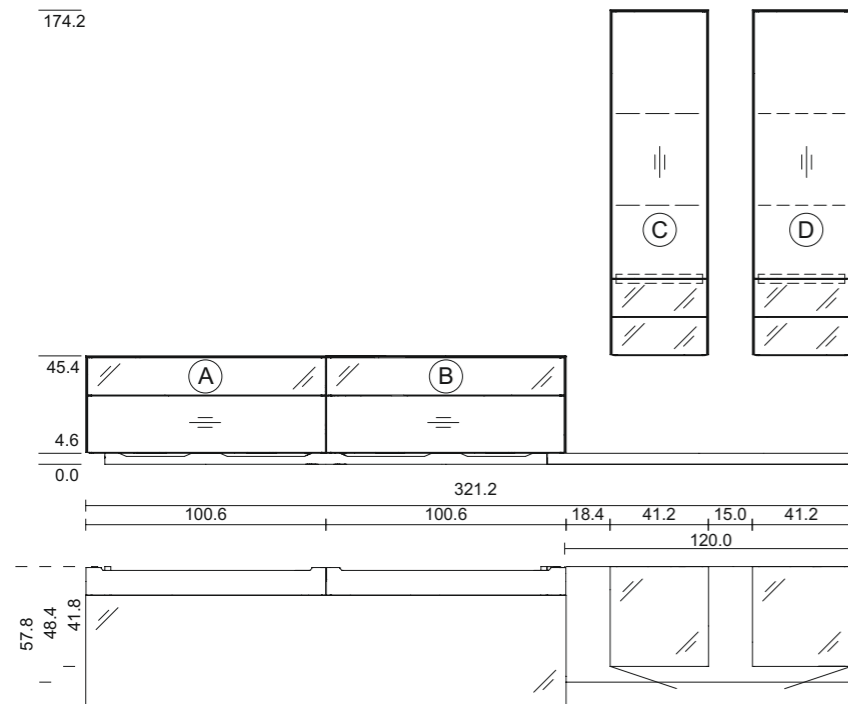

summary



wood type: cherry
glass: bronze

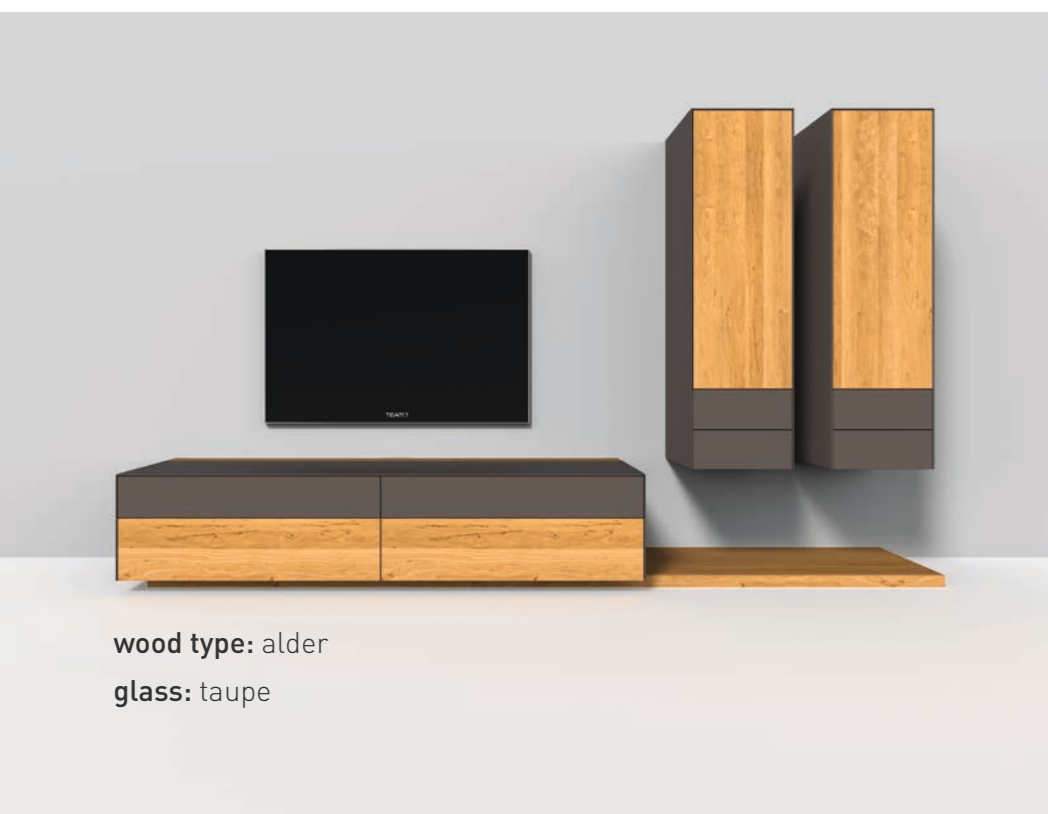

wood type: alder
glass: taupe

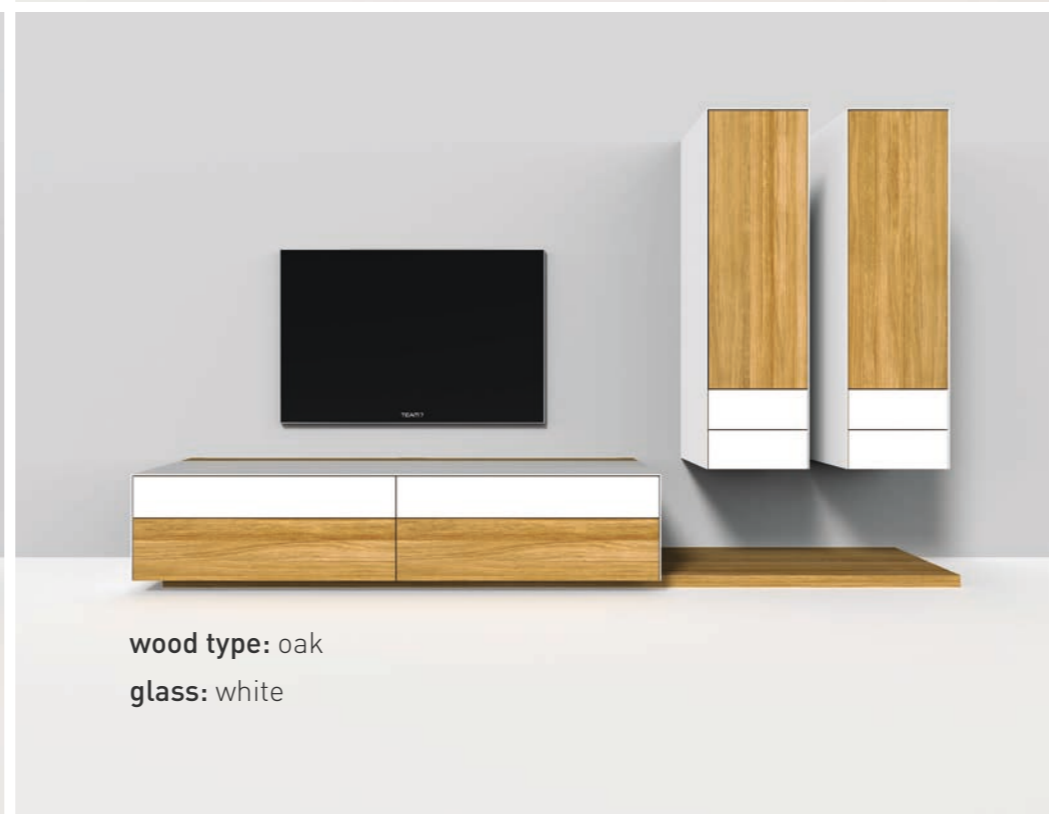

wood type: oak
glass: white

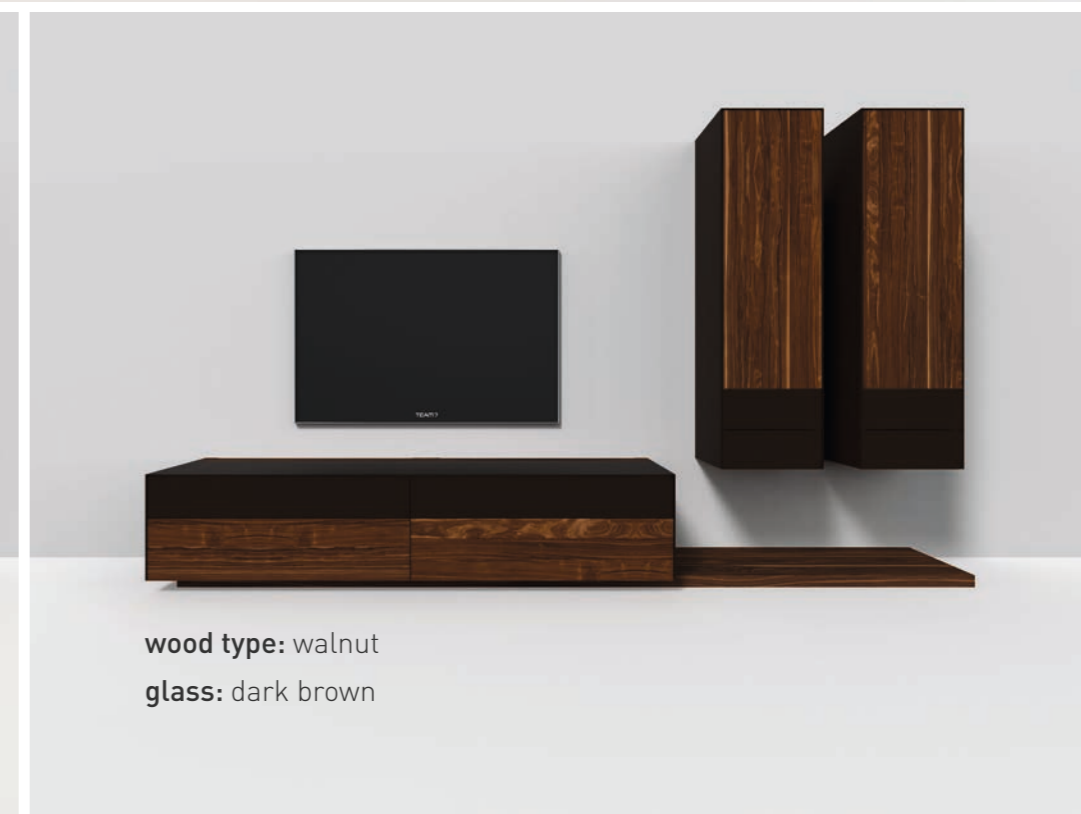

wood type: walnut
glass: dark brown



cubus pure wall unit, CPWW 11

TEAM7



cubus pure wall unit, CPWW 11

TEAM7

TEAM7

cubus pure wall unit

CPWW 11

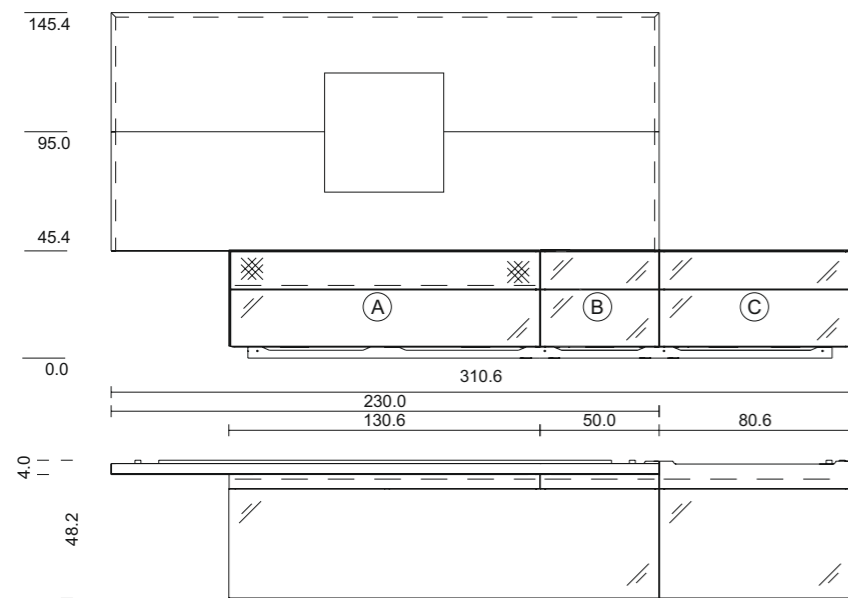

summary



wood type: wild oak
glass: taupe (left), black (right)
loudspeaker flap fabric: acoustic fabric light grey



wood type: cherry
glass: anthracite (left), white (right)
loudspeaker flap fabric: acoustic fabric light grey



wood type: walnut
glass: taupe (left), dark brown (right)
loudspeaker flap fabric: acoustic fabric black



wood type: oak white oil
glass: bronze (left), dark brown (right)
loudspeaker flap fabric: acoustic fabric black



cubus pure wall unit, CPWW 15

TEAM7



cubus pure wall unit, CPWW 15

TEAM7

TEAM7

cabus pure wall unit

CPWW 15

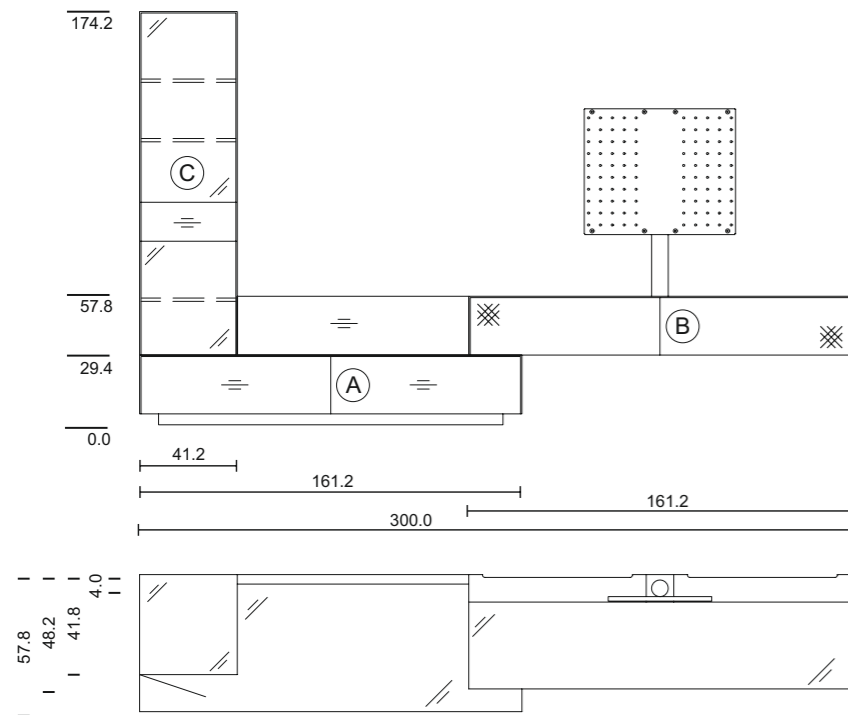

summary



wood type: oak
glass: bronze (top left), black (bottom left), taupe (right)
loudspeaker flap fabric: acoustic fabric light grey



wood type: beech heartwood
glass: sand (top left), dark brown (bottom left), sludge (right)
loudspeaker flap fabric: acoustic fabric light grey



wood type: cherry
glass: medium grey (top left), black (bottom left), white (right)
loudspeaker flap fabric: acoustic fabric light grey



wood type: walnut
glass: bronze (top left), dark brown (bottom left), pebble (right)
loudspeaker flap fabric: acoustic fabric black



cubus pure wall unit, CPWW 16

TEAM7



cubus pure wall unit, CPWW 16

TEAM7

TEAM7

cabus pure wall unit

CPWW 16

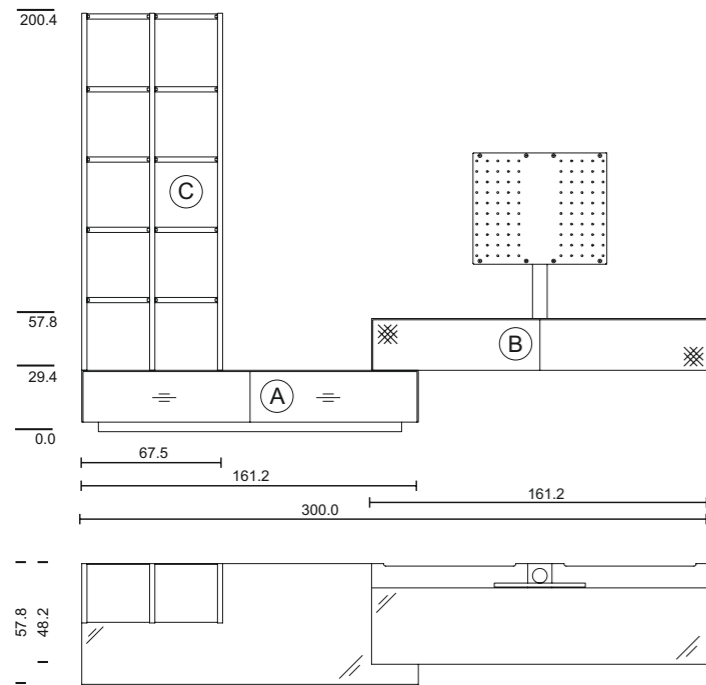

summary



wood type: walnut
glass: anthracite (left), white (right)
loudspeaker flap fabric: acoustic fabric black



wood type: beech heartwood
glass: dark brown (left), sludge (right)
loudspeaker flap fabric: acoustic fabric black



wood type: oak
glass: dark brown (left), bronze (right)
loudspeaker flap fabric: acoustic fabric black



wood type: cherry
glass: taupe (left), dark brown (right)
loudspeaker flap fabric: acoustic fabric light grey



cubus pure wall unit, CPWW 17

TEAM7



cubus pure wall unit, CPWW 17

TEAM7

TEAM7

cubus pure wall unit

CPWW 17

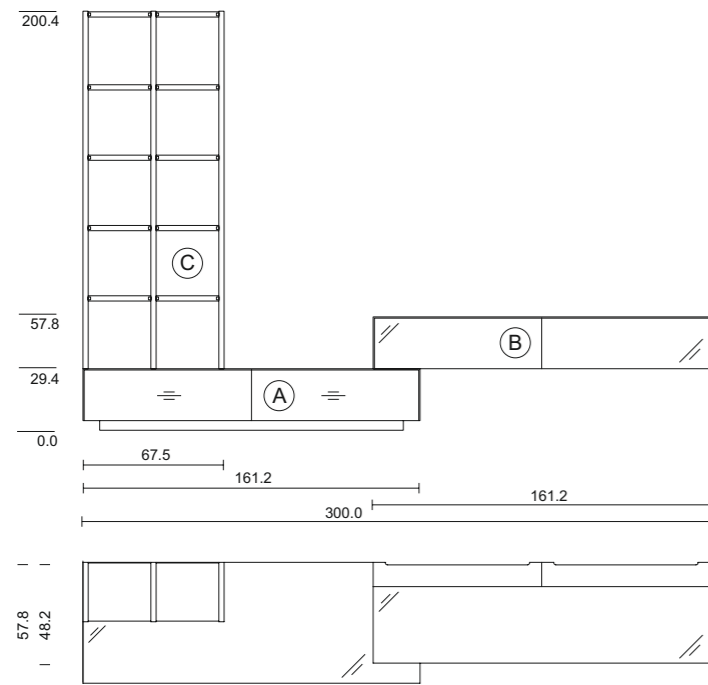

summary



wood type: walnut
glass: dark brown (left), bronze (right)



wood type: alder
glass: dark brown (left), taupe (right)



wood type: beech heartwood
glass: black (left), anthracite (right)



wood type: oak
glass: black (left), medium grey (right)



cubus pure wall unit, CPWW 18

TEAM7



cubus pure wall unit, CPWW 18

TEAM7

TEAM7

cubus pure wall unit

CPWW 18

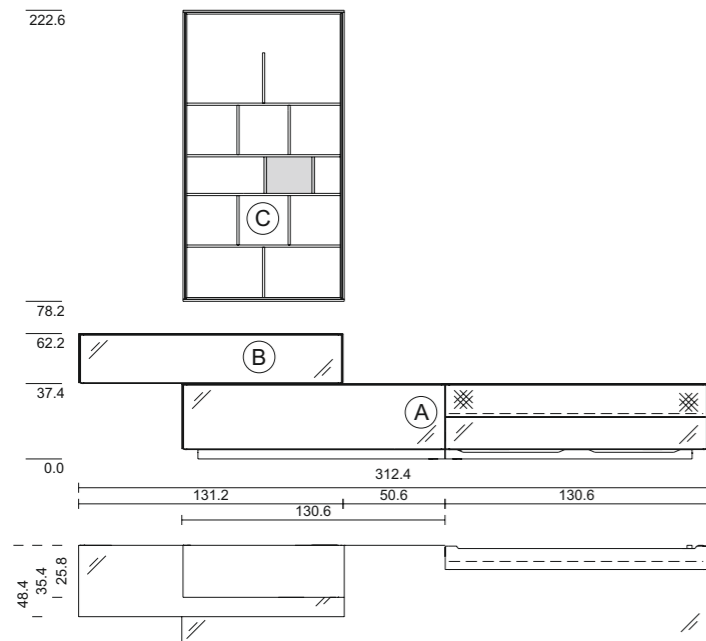

summary



wood type: walnut
glass: bronze (design element, bottom), black (left)
leather compartment: black-brown
loudspeaker flap fabric: acoustic fabric black

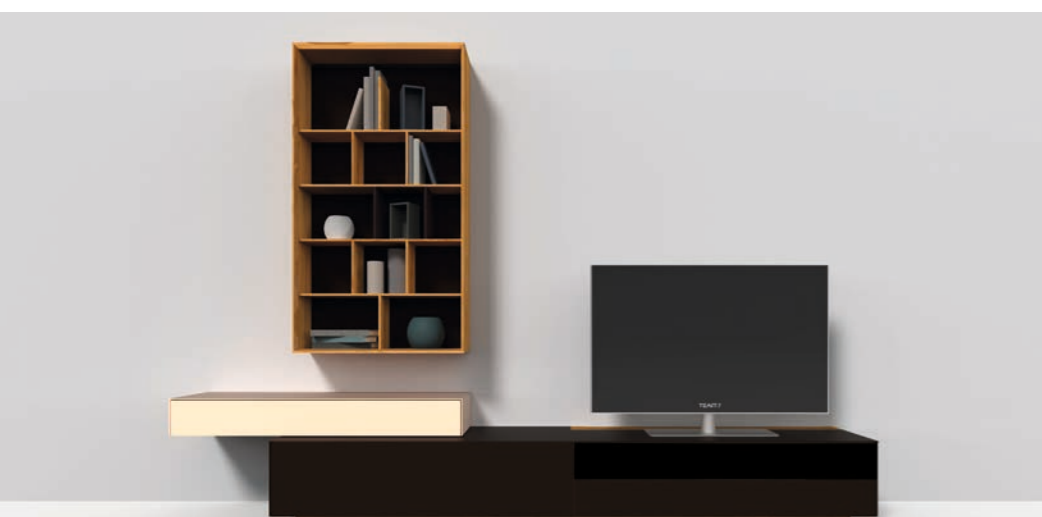

wood type: beech heartwood
glass: dark brown (design element, bottom), sand (left)
leather compartment: dark brown
loudspeaker flap fabric: acoustic fabric black



wood type: oak
glass: anthracite (design element, bottom), white (left)
leather compartment: anthracite
loudspeaker flap fabric: acoustic fabric light grey



wood type: cherry
glass: pebble (design element, bottom), dark brown (left)
leather compartment: black-brown
loudspeaker flap fabric: acoustic fabric black



cubus pure wall unit, CPWW 19

TEAM7



cubus pure wall unit, CPWW 19

TEAM7

TEAM7

cubus pure wall unit

CPWW 19

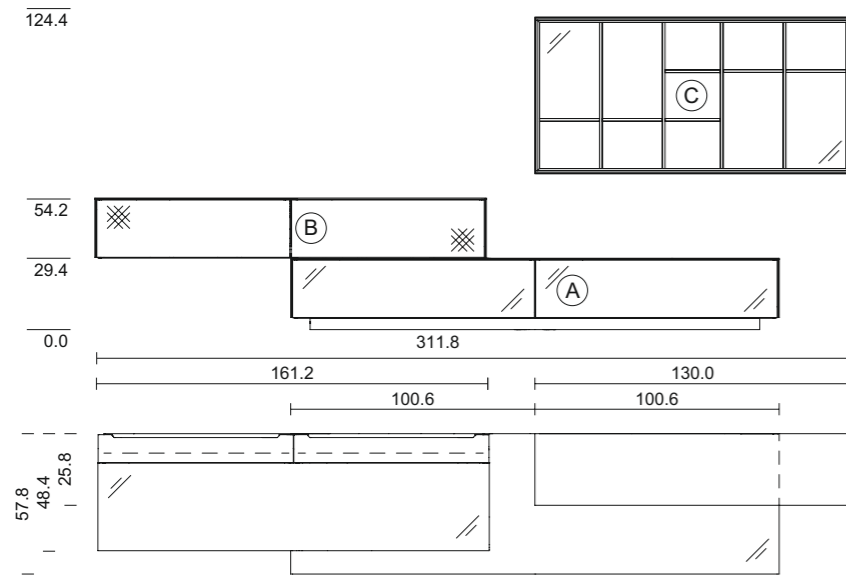

summary



wood type: oak
glass: taupe (design element, top left), dark brown (bottom)
loudspeaker flap fabric: acoustic fabric light grey

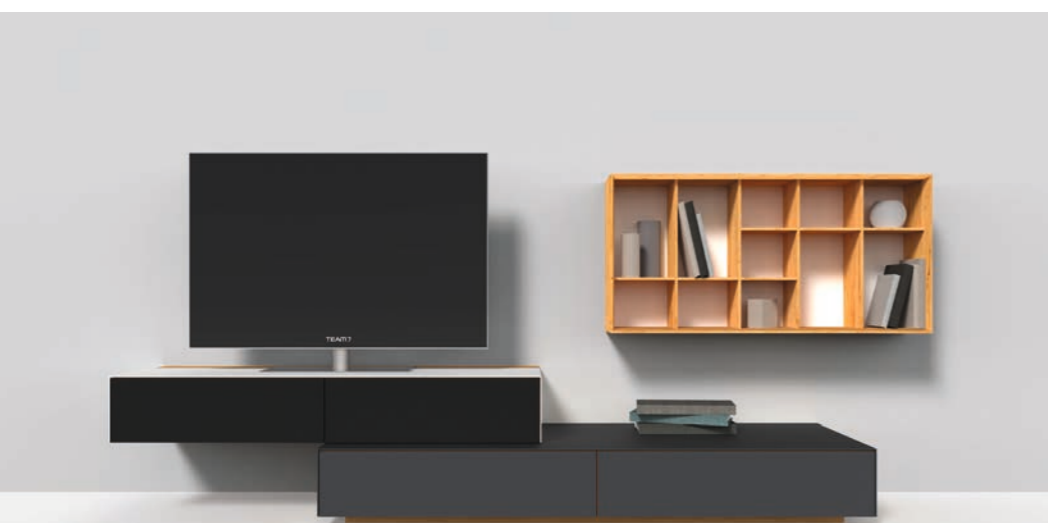

wood type: alder
glass: white (design element, top left), anthracite (bottom)
loudspeaker flap fabric: acoustic fabric black

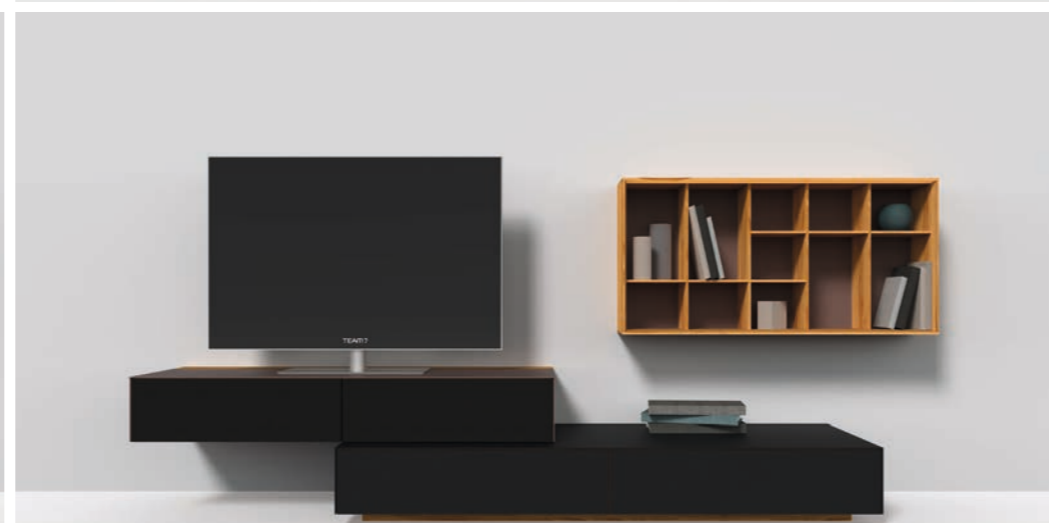

wood type: beech heartwood
glass: sludge (design element, top left), black (bottom)
loudspeaker flap fabric: acoustic fabric black



wood type: walnut
glass: white (top left), medium grey (design element, bottom)
loudspeaker flap fabric: acoustic fabric light grey



cubus pure wall unit, CPWW 20

TEAM7



cubus pure wall unit, CPWW 20

TEAM7

TEAM7

cabus pure wall unit

CPWW 20

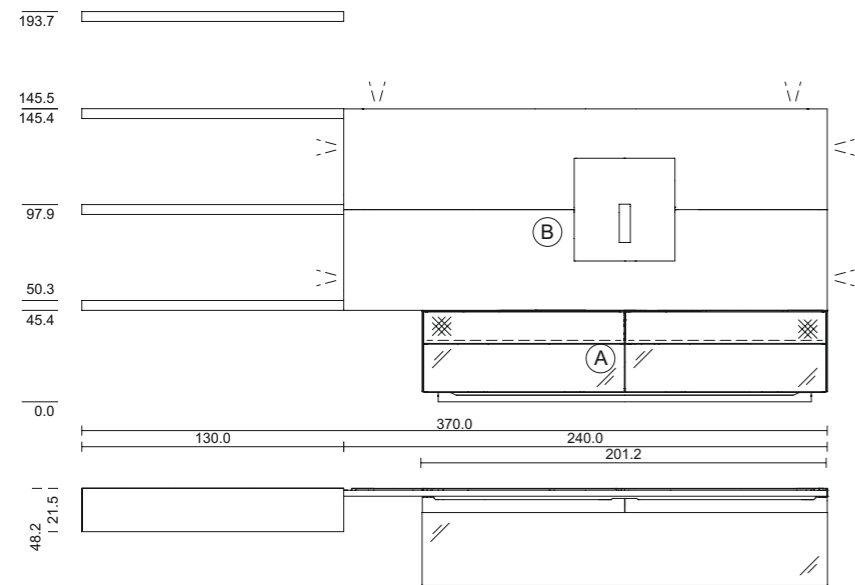

summary



wood type: wild walnut
glass: pebble
loudspeaker flap fabric: acoustic fabric black



wood type: beech heartwood
glass: medium grey
loudspeaker flap fabric: acoustic fabric light grey



wood type: oak
glass: black
loudspeaker flap fabric: acoustic fabric light grey



wood type: cherry
glass: white
loudspeaker flap fabric: acoustic fabric black



cubus pure wall unit, CPWW 22

TEAM7



cubus pure wall unit, CPWW 22

TEAM7

cubus pure wall unit

CPWW 22

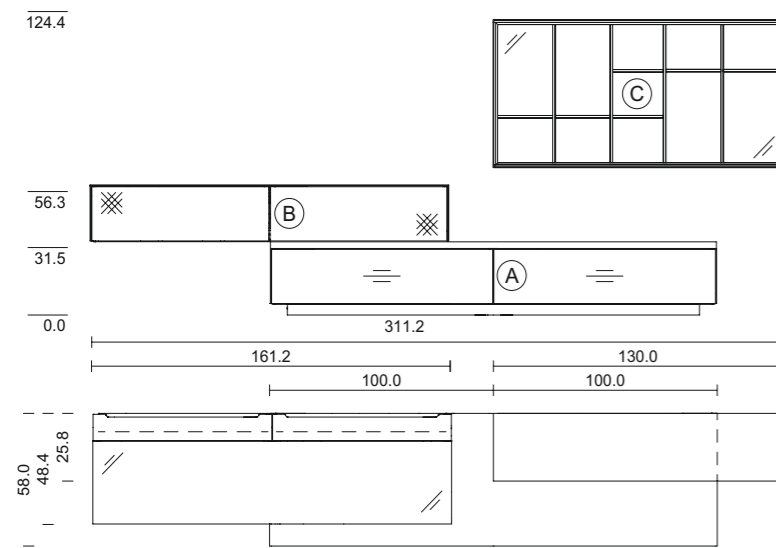

wood type: oak white oil
glass: white
loudspeaker flap fabric: acoustic fabric light grey



wood type: alder
glass: sand
loudspeaker flap fabric: acoustic fabric black

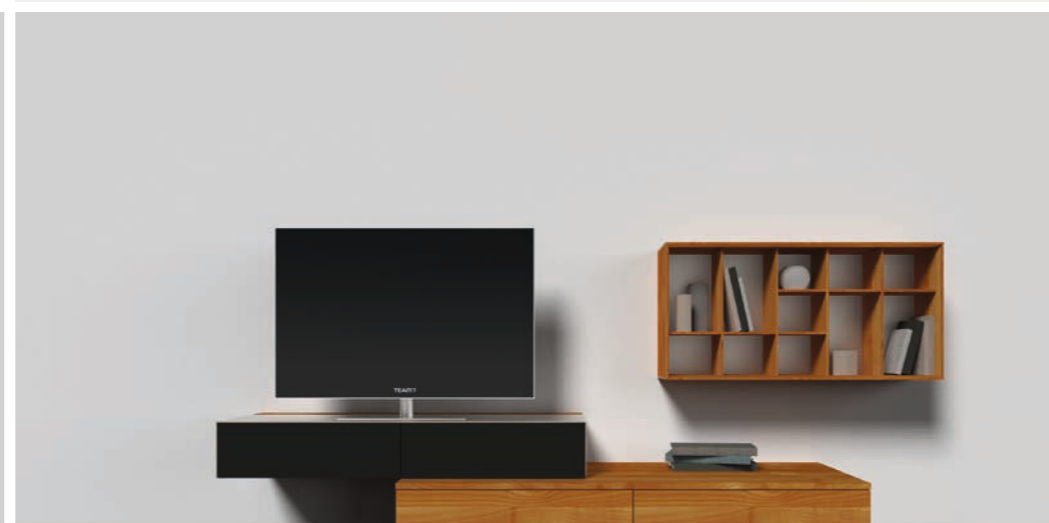

wood type: beech heartwood
glass: pearl
loudspeaker flap fabric: acoustic fabric black



wood type: walnut
glass: bronze
loudspeaker flap fabric: acoustic fabric black



cubus pure wall unit, CPWW 23

TEAM7



cubus pure wall unit, CPWW 23

TEAM7

TEAM7

cubus pure wall unit

CPWW 23

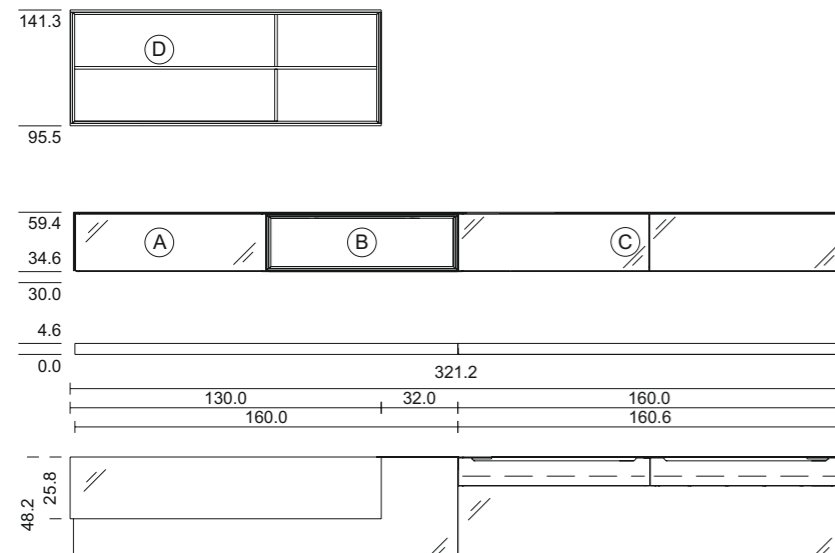

summary



wood type: oak white oil
glass: white (design element), taupe (bottom)

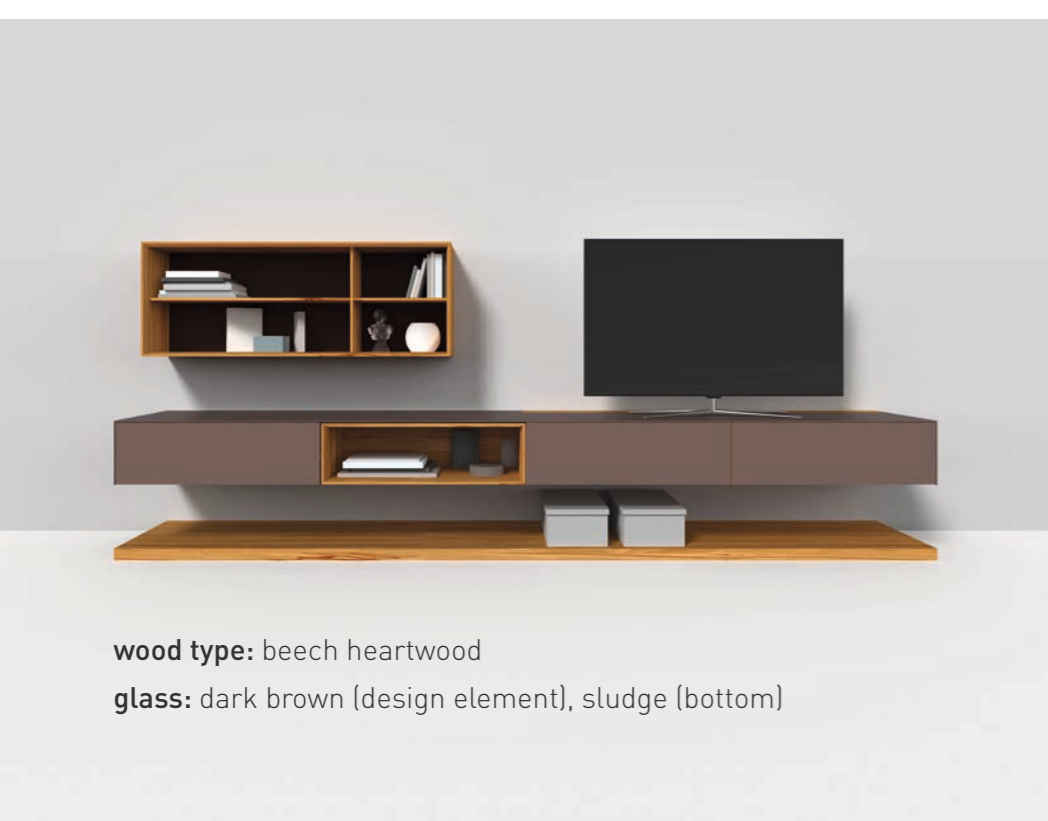

wood type: beech heartwood
glass: dark brown (design element), sludge (bottom)

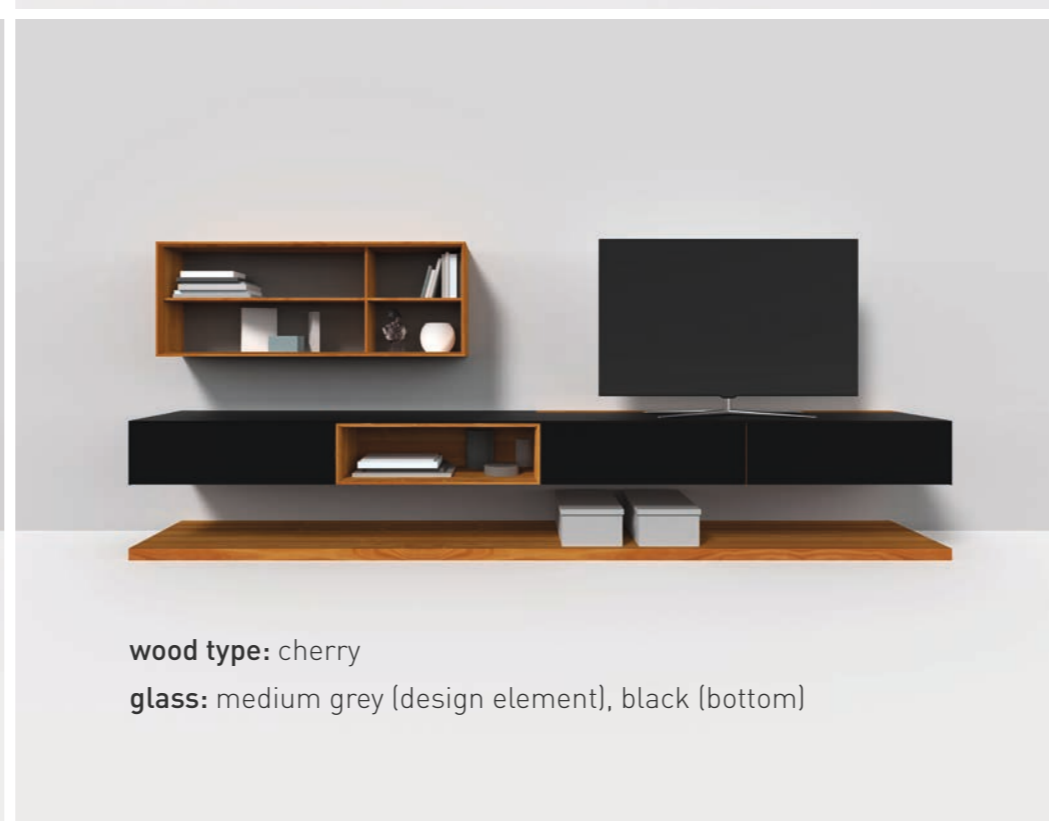

wood type: cherry
glass: medium grey (design element), black (bottom)

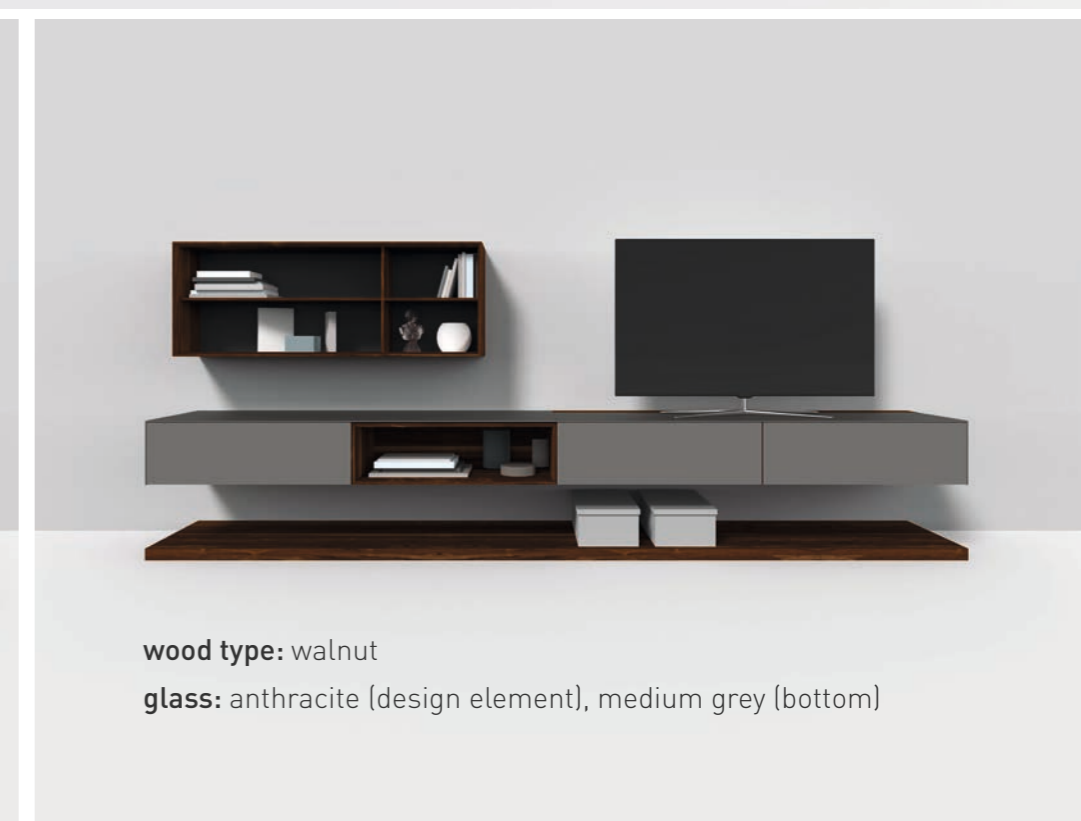

wood type: walnut
glass: anthracite (design element), medium grey (bottom)



cubus pure wall unit, CPWW 24

TEAM7



cubus pure wall unit, CPWW 24

TEAM7

TEAM7

cabus pure wall unit

CPWW 24

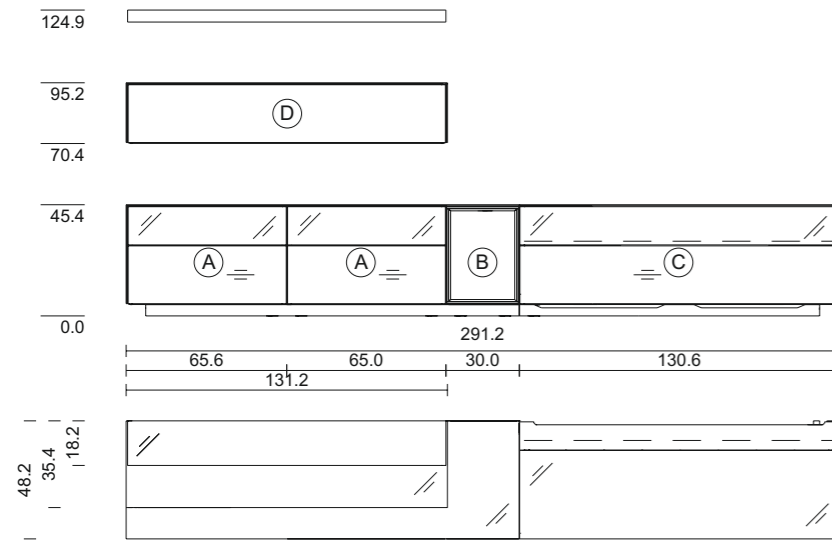

summary

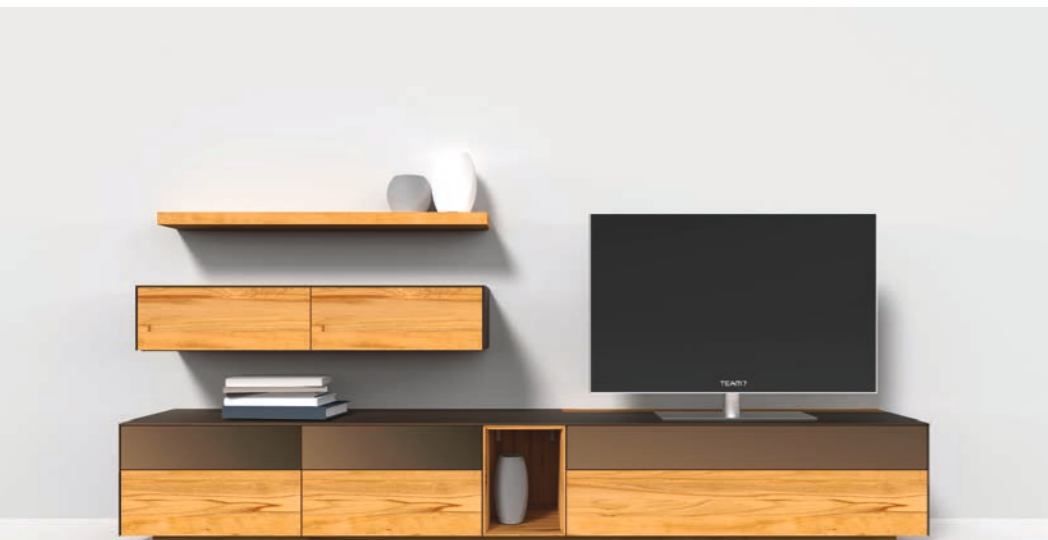



cubus pure wall unit, CPWW 24 A

TEAM7



cubus pure wall unit, CPWW 24 A

TEAM7

TEAM7

cubus pure wall unit

CPWW 24 A

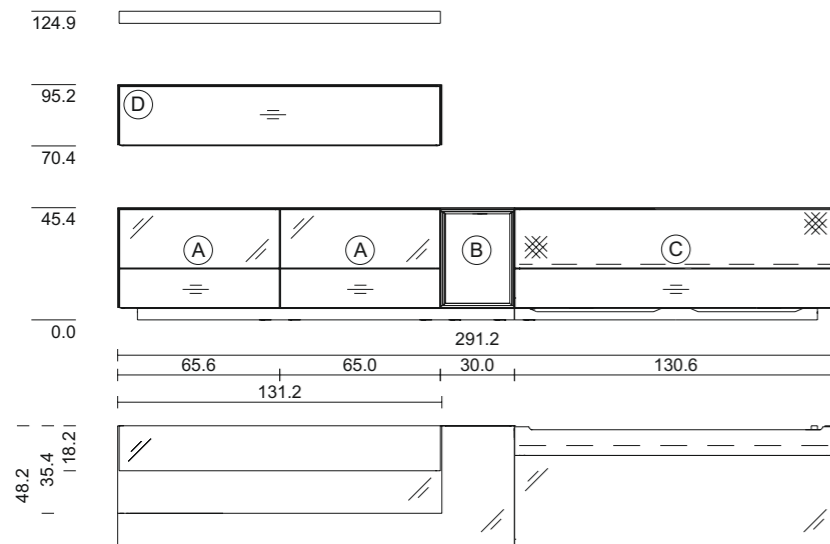

summary



wood type: walnut
glass: pearl
loudspeaker flap fabric: acoustic fabric black

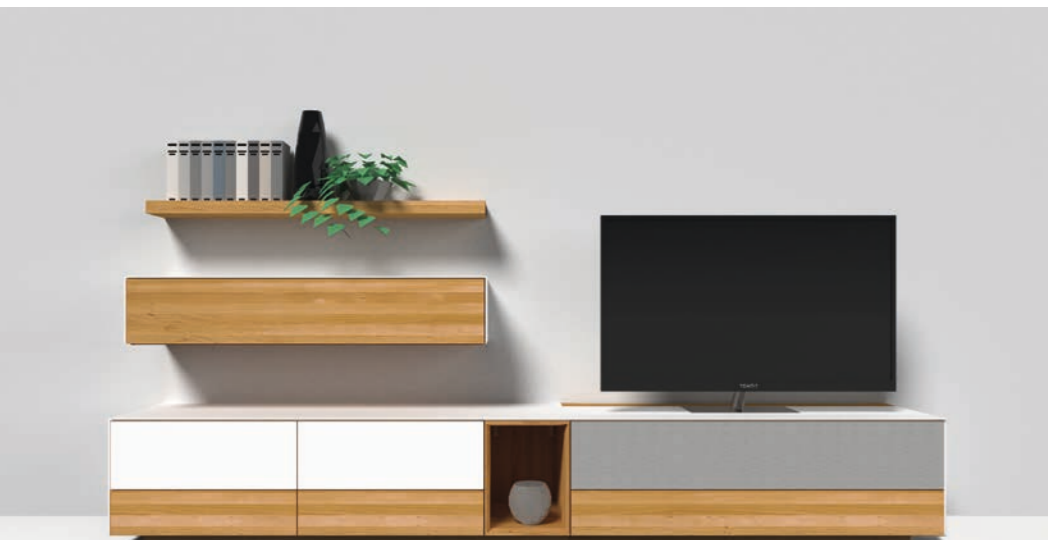

wood type: alder
glass: white
loudspeaker flap fabric: acoustic fabric light grey



wood type: oak
glass: medium grey
loudspeaker flap fabric: acoustic fabric light grey

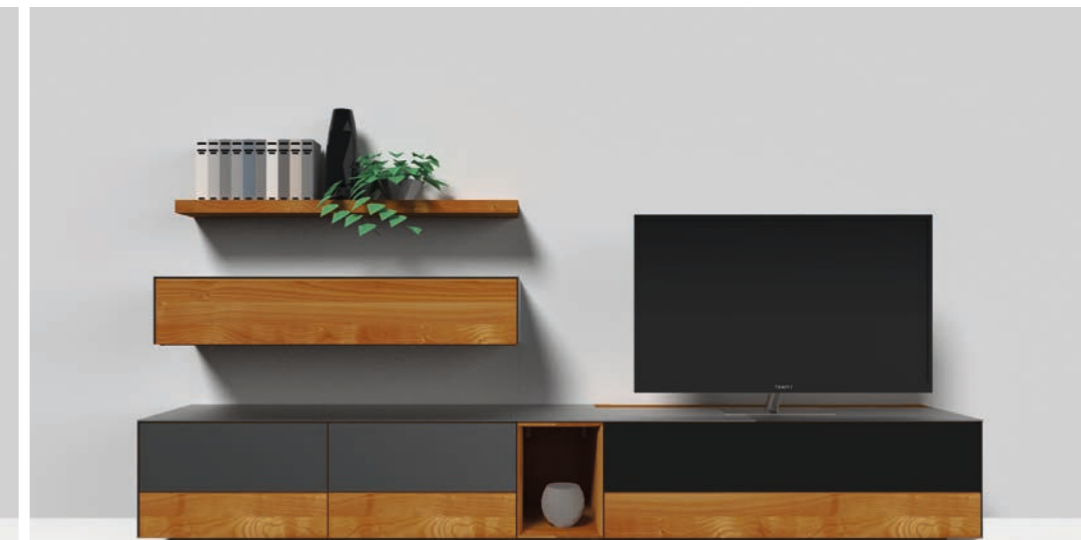

wood type: cherry
glass: steel
loudspeaker flap fabric: acoustic fabric black



cubus pure wall unit, CPWW 25

TEAM7



cubus pure wall unit, CPWW 25

TEAM7

TEAM7

cubus pure wall unit

CPWW 25

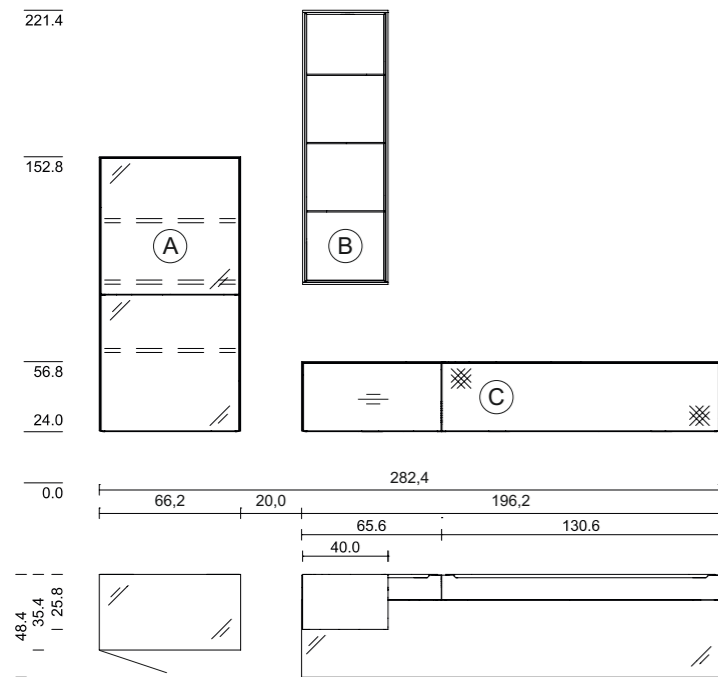

summary



wood type: walnut
glass: steel
loudspeaker flap fabric: acoustic fabric black



wood type: beech heartwood
glass: pearl
loudspeaker flap fabric: acoustic fabric black



wood type: oak
glass: bronze
loudspeaker flap fabric: acoustic fabric black



wood type: cherry
glass: steel
loudspeaker flap fabric: acoustic fabric black



cubus pure wall unit, CPWW 25 A

TEAM7



cubus pure wall unit, CPWW 25 A

TEAM7

TEAM7

cubus pure wall unit

CPWW 25 A

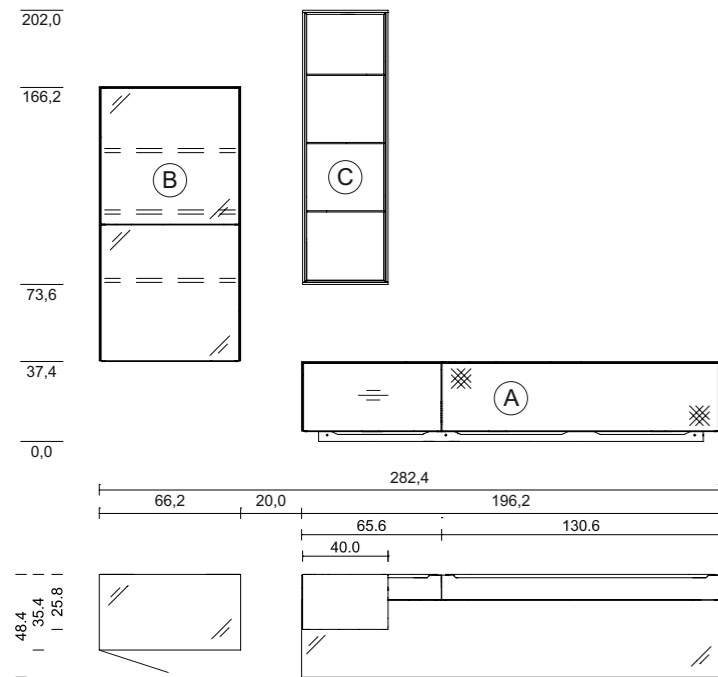

summary



wood type: oak white oil
glass: pearl
loudspeaker flap fabric: acoustic fabric black



wood type: alder
glass: white
loudspeaker flap fabric: acoustic fabric black



wood type: beech heartwood
glass: medium grey
loudspeaker flap fabric: acoustic fabric black



wood type: walnut
glass: pearl
loudspeaker flap fabric: acoustic fabric black



cubus pure wall unit, CPWW 26

TEAM7



cubus pure wall unit, CPWW 26

TEAM7

TEAM7

cubus pure wall unit

CPWW 26

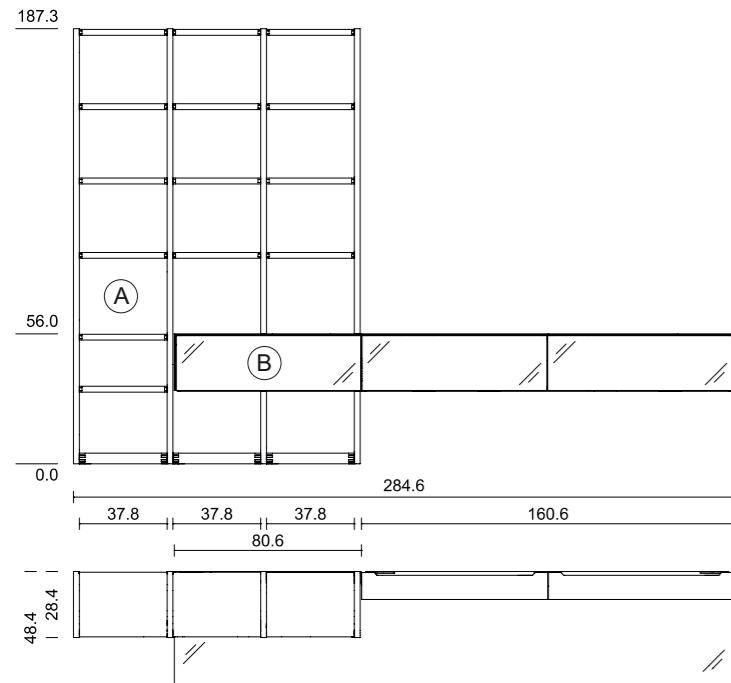

summary



wood type: oak white oil
glass: pearl



wood type: alder
glass: dark brown



wood type: beech heartwood
glass: white



wood type: walnut
glass: taupe



cubus pure wall unit, CPWW 27

TEAM7



cubus pure wall unit, CPWW 27

TEAM7

TEAM7

cubus pure wall unit

CPWW 27

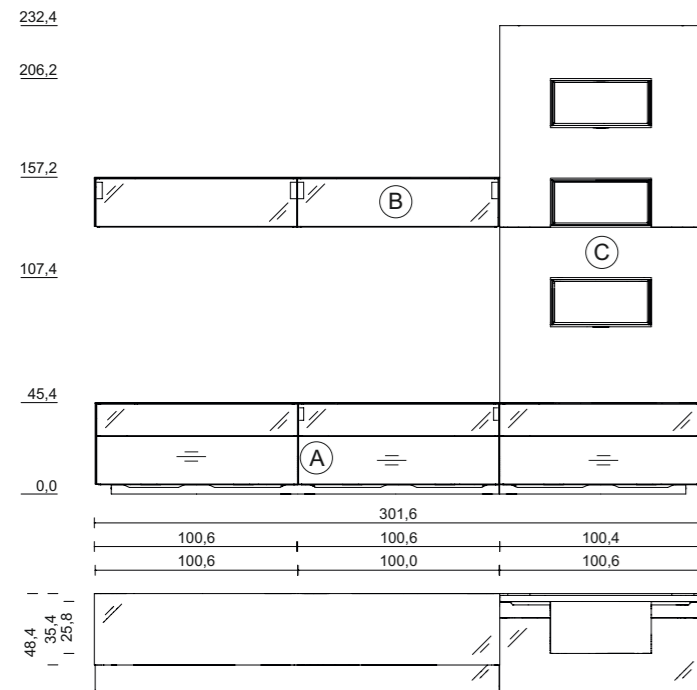

summary



wood type: oak white oil
glass: medium grey



wood type: beech heartwood
glass: sludge



wood type: cherry
glass: steel



wood type: walnut
glass: pearl



cubus pure wall unit, CPWW 28

TEAM7



cubus pure wall unit, CPWW 28

TEAM7

TEAM7

cubus pure wall unit

CPWW 28

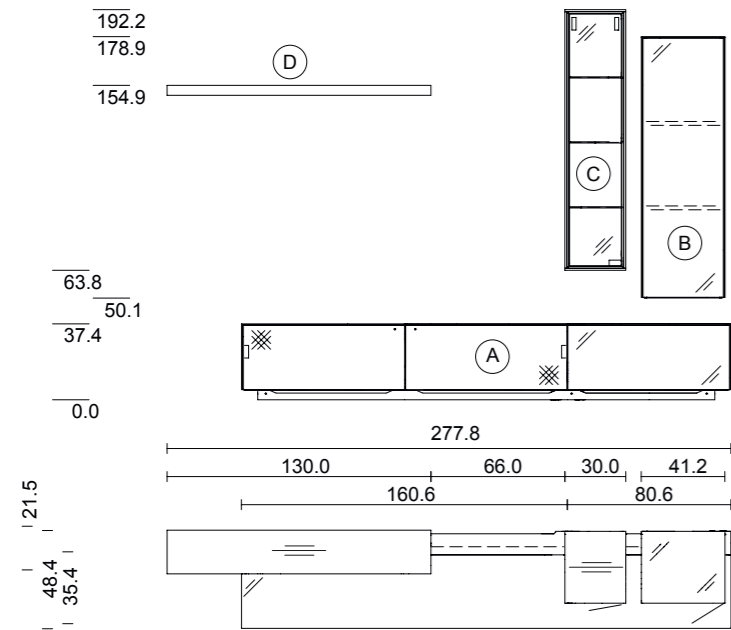

summary



wood type: oak
glass: clear glass, white
fabric speaker flap: light grey acoustic fabric



wood type: walnut
glass: smoked glass, medium grey
fabric speaker flap: black acoustic fabric



wood type: beech heartwood
glass: smoked glass, sand
fabric speaker flap: black acoustic fabric



wood type: cherry
glass: clear glass, anthracite
fabric speaker flap: black acoustic fabric



cubus pure wall unit, CPWW 30

TEAM7



cubus pure wall unit, CPWW 30

TEAM7

TEAM 7

cube pure wall unit

CPWW 30

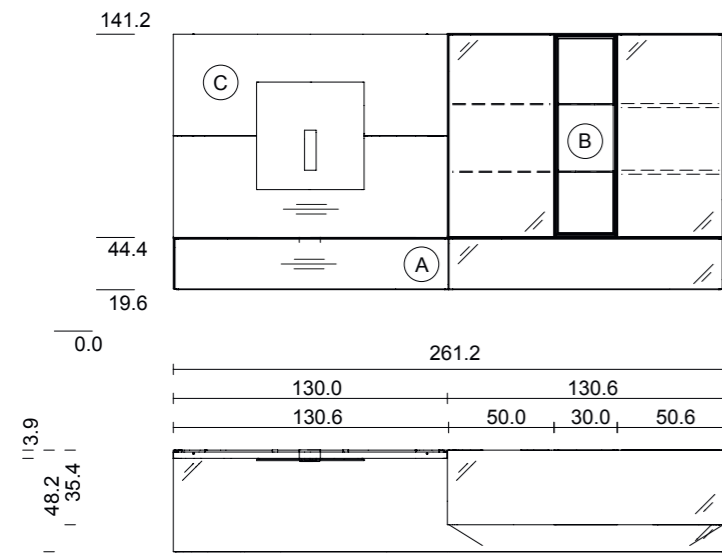

summary



wood type: beech heartwood
glass: anthracite



wood type: walnut
glass: pebble



wood type: oak
glass: steel



wood type: alder
glass: white



cubus pure wall unit, CPWW 31

TEAM7



cubus pure wall unit, CPWW 31

TEAM7

cubus pure wall unit

CPWW 31

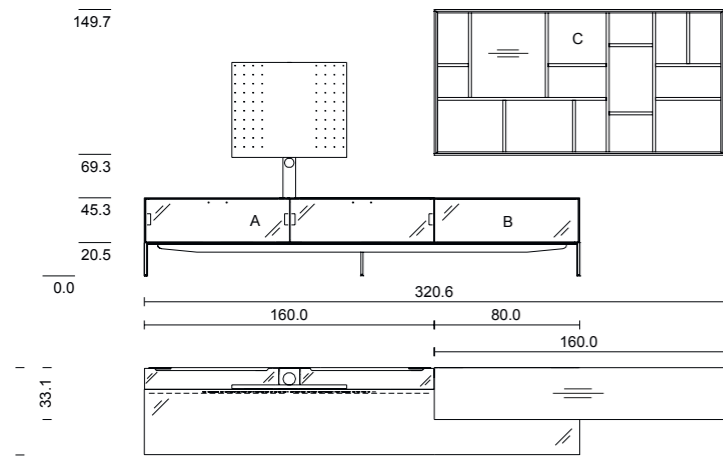

wood type: walnut
glass: white
metal frame base: snow white



wood type: oak white oil
glass: medium grey
metal frame base: stone grey



wood type: walnut
glass: taupe
metal frame base: night blue



wood type: oak
glass: bronze
metal frame base: earth brown

TEAM 7 Natürlich Wohnen GmbH

Austria	4910 Ried/Innkreis, Braunauer Straße 26
Germany	45966 Gladbeck, Gustav Stresemann Straße 50
Switzerland/Italy	5643 Sins/AG, Tschampani 30
telephone	+43 7752 977-700
e-mail	info@team7.at
internet	www.team7-home.com

TEAM 7