



esempi di progettazione *cubus pure pareti attrezzate*

TEAM7



CPWW 1

BK, EI, KB, NB



CPWW 2

ER, BK, EI, NB



CPWW 4

BK, EI, KB, NB



CPWW 10

ER, EI, KB, NB



CPWW 11

EIWI, KB, NB, EI-W



CPWW 15

BK, EI, KB, NB



CPWW 16

BK, EI, KB, NB



CPWW 17

ER, BK, EI, NB



CPWW 18

BK, EI, KB, NB



CPWW 19

ER, BK, EI, NB



CPWW 20

BK, EI, KB, NBWI



CPWW 22

ER, KB, NB, EI-W



CPWW 23

BK, KB, NB, EI-W



CPWW 24

BK, EIVE, NB, EI-W



CPWW 24 A

ER, EI, KB, NB



CPWW 25

BK, EI, KB, NB



CPWW 25 A

ER, BK, NB, EI-W



CPWW 26

ER, BK, EI-W, NB



CPWW 27

ER, BK, EI-W, NB



CPWW 28

BK, EI, KB, NB



CPWW 30

ER, BK, EI, KB



CPWW 31

BK, EI-W, KB, NB



cubus pure parete attrezzata, CPWW 1

TEAM7



cubus pure parete attrezzata, CPWW 1

TEAM7

TEAM7

cabus pure parete attrezzata

CPWW 1

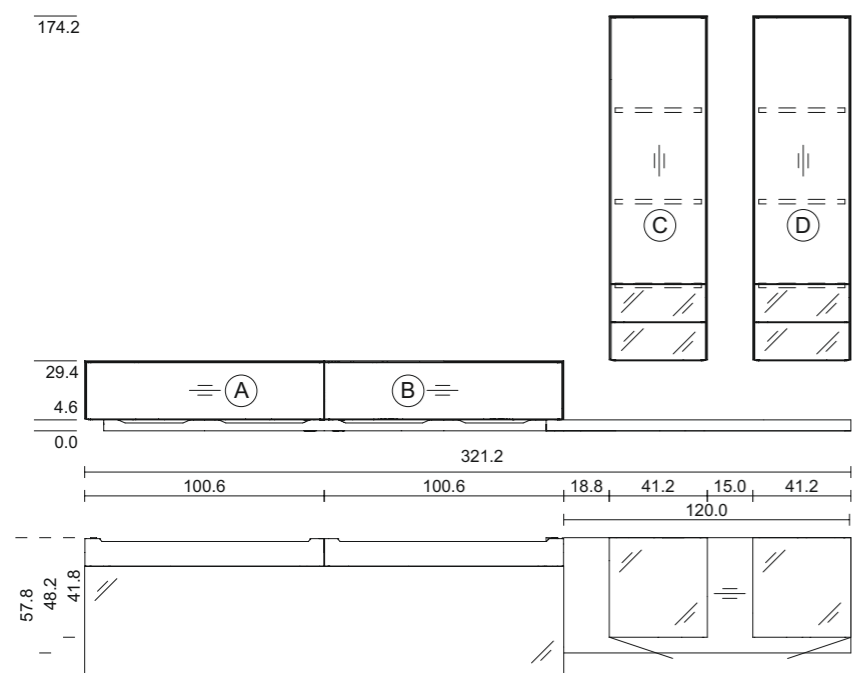

prospetto



tipo di legno: noce
vetro: bianco

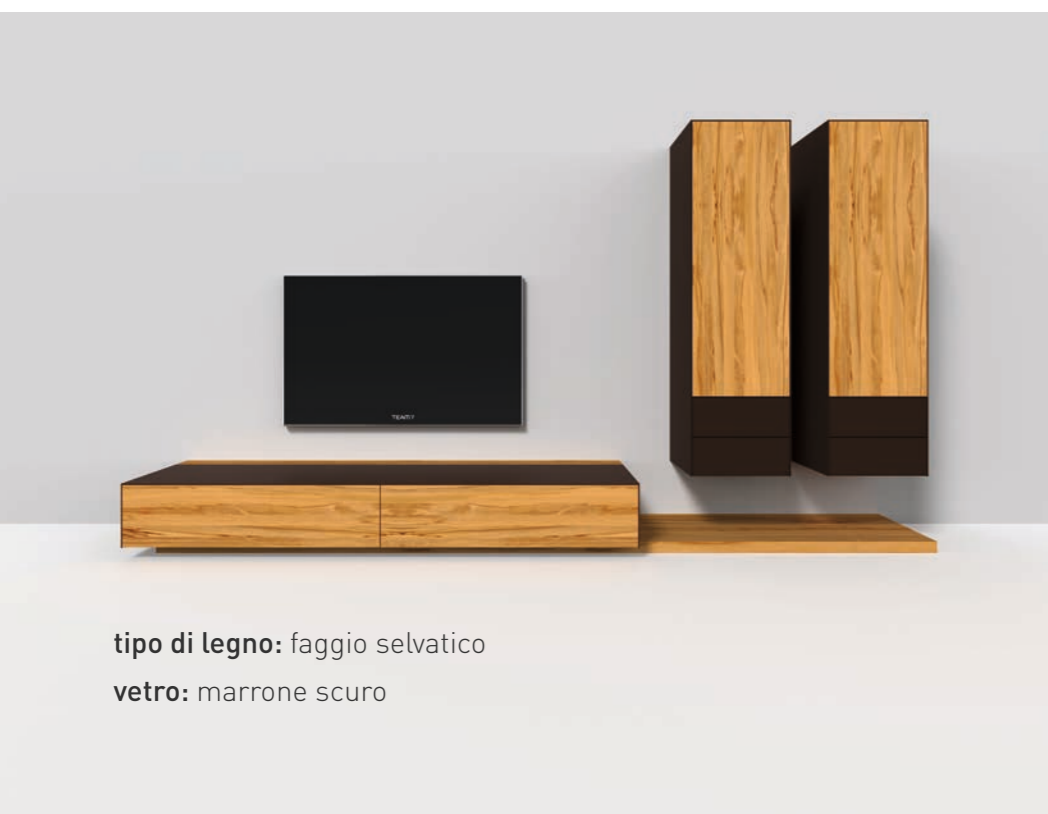

tipo di legno: faggio selvatico
vetro: marrone scuro

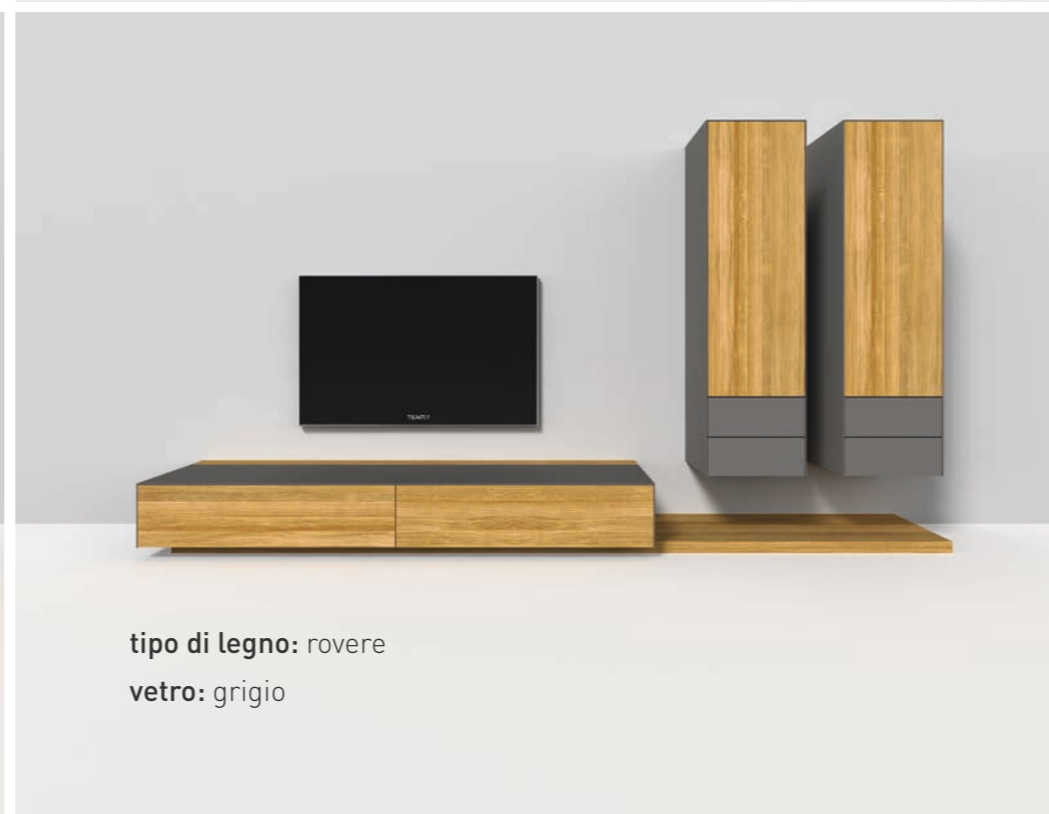

tipo di legno: rovere
vetro: grigio



tipo di legno: ciliegio
vetro: grigio talpa



cubus pure parete attrezzata, CPWW 2

TEAM7



cubus pure parete attrezzata, CPWW 2

TEAM7

TEAM7

cubus pure parete attrezzata

CPWW 2

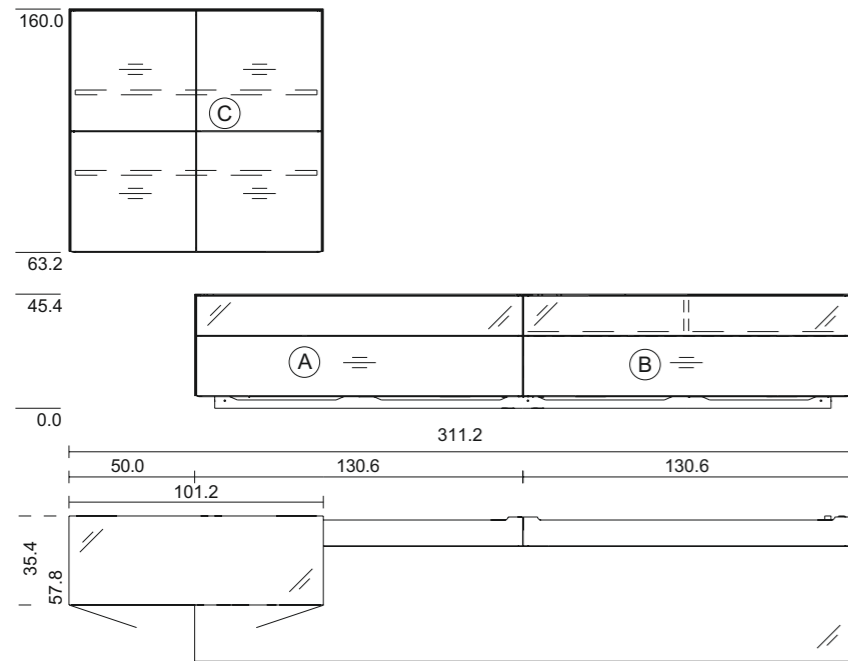

prospetto



tipo di legno: rovere
vetro: grigio talpa



tipo di legno: ontano
vetro: bianco

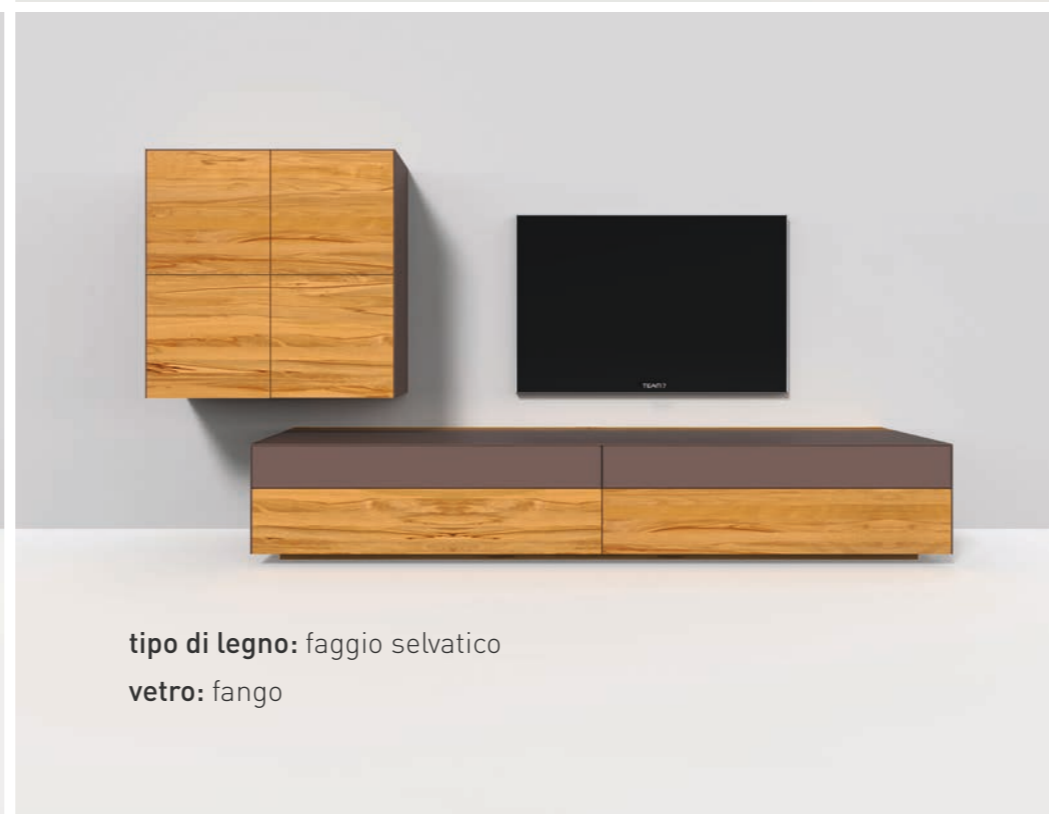

tipo di legno: faggio selvatico
vetro: fango



tipo di legno: noce
vetro: selce

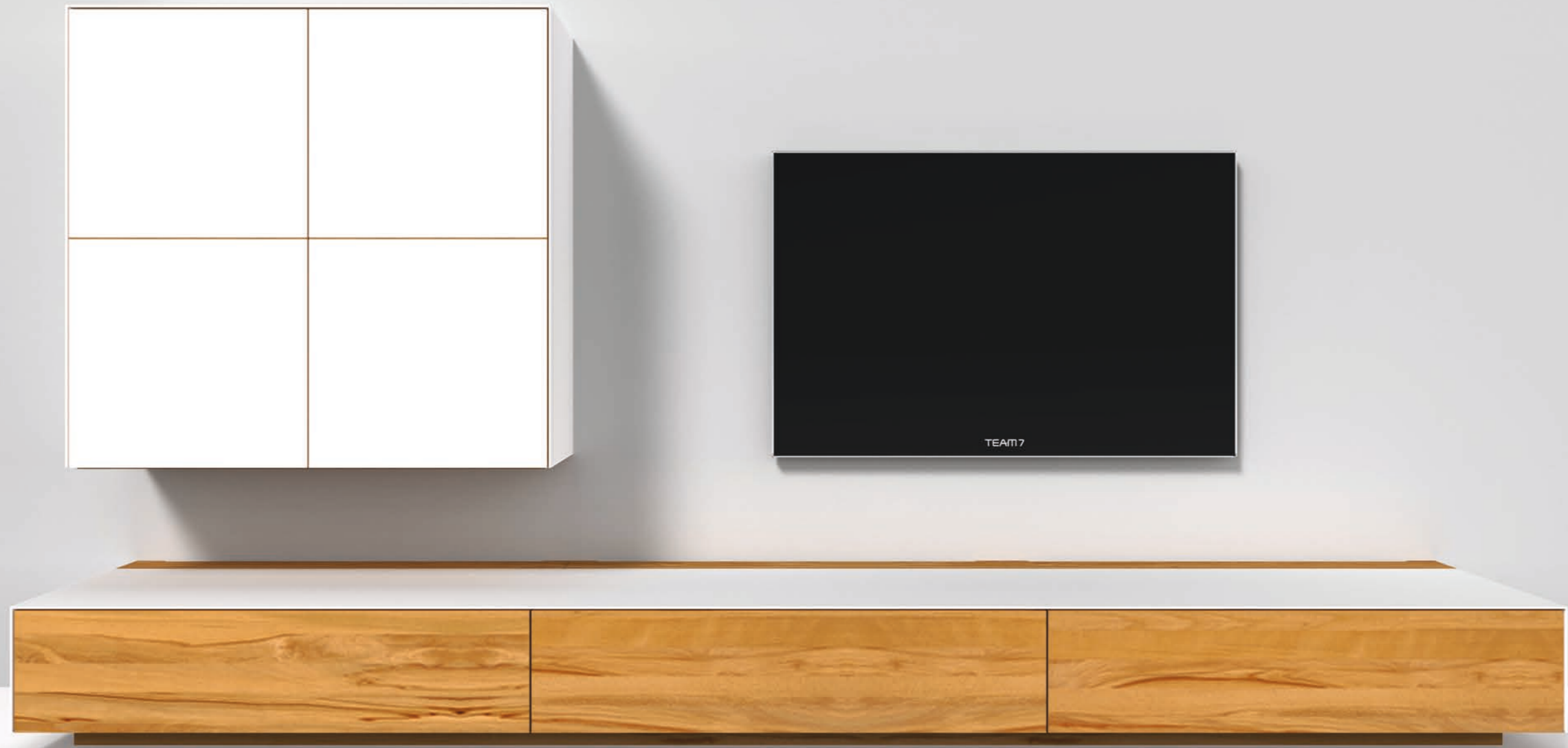

cubus pure parete attrezzata, CPWW 4

TEAM7



cubus pure parete attrezzata, CPWW 4

TEAM7

TEAM7

cubus pure parete attrezzata

CPWW 4

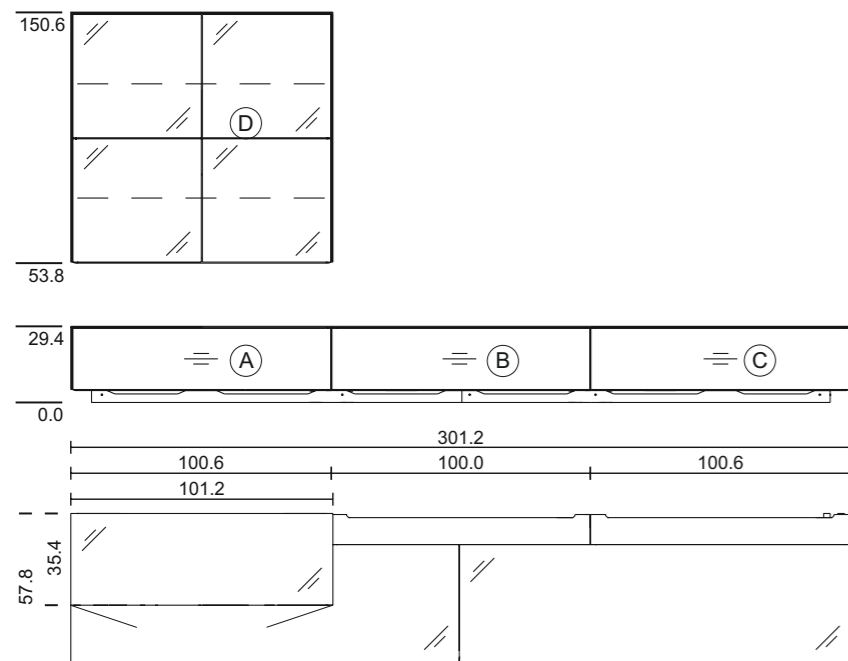

prospetto



tipo di legno: faggio selvatico
vetro: bianco



tipo di legno: rovere
vetro: grigio



tipo di legno: ciliegio
vetro: antracite

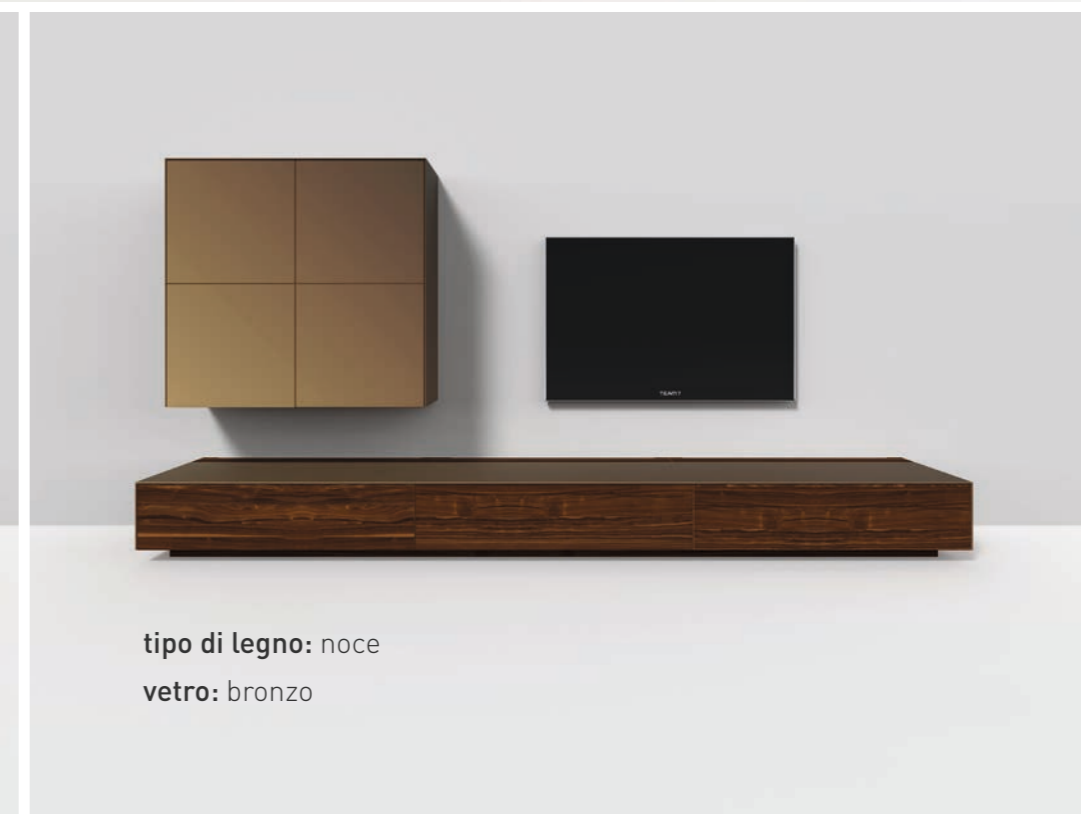

tipo di legno: noce
vetro: bronzo



cubus pure parete attrezzata, CPWW 10

TEAM7



cubus pure parete attrezzata, CPWW 10

TEAM7

TEAM7

cubus pure parete attrezzata

CPWW 10

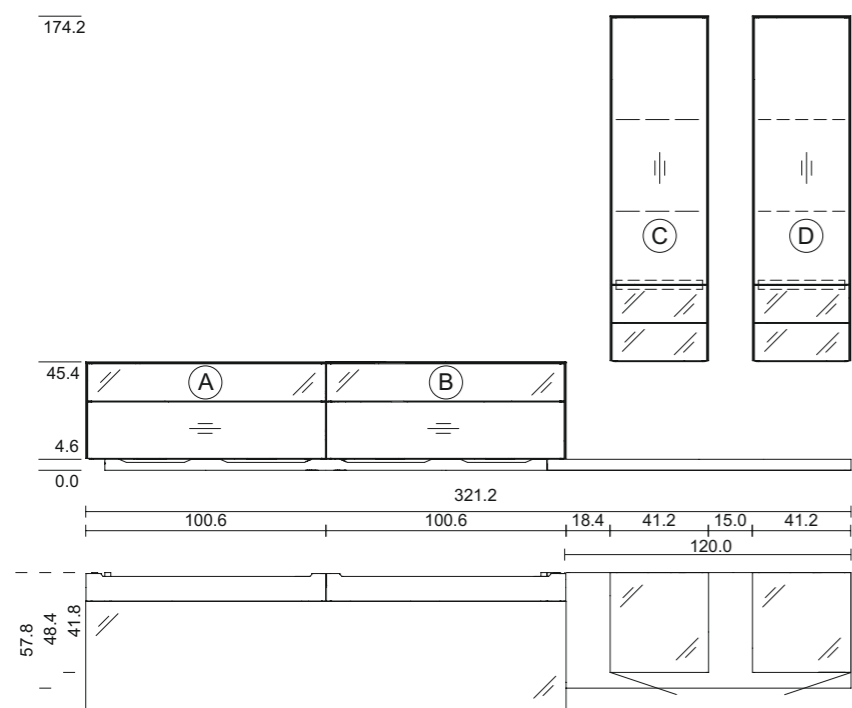

prospetto



tipo di legno: ciliegio
vetro: bronzo



tipo di legno: ontano
vetro: grigio talpa

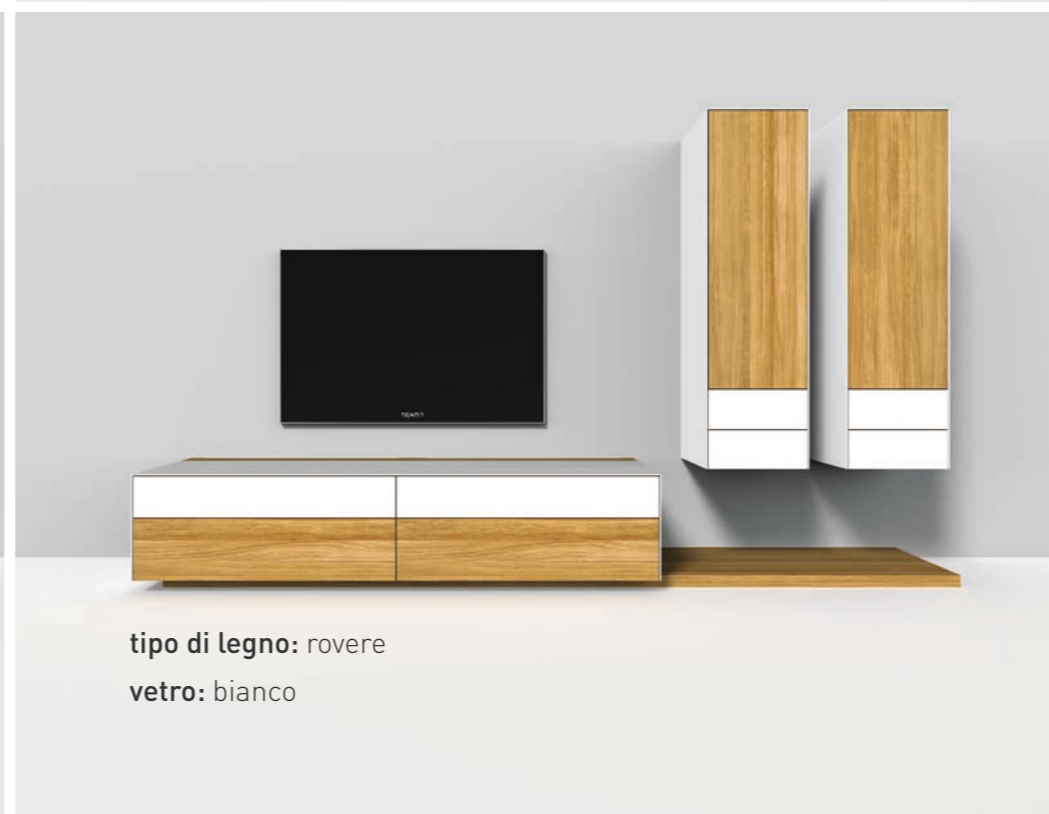

tipo di legno: rovere
vetro: bianco



tipo di legno: noce
vetro: marrone scuro



cubus pure parete attrezzata, CPWW 11

TEAM7



cubus pure parete attrezzata, CPWW 11

TEAM7

TEAM7

cabus pure parete attrezzata

CPWW 11

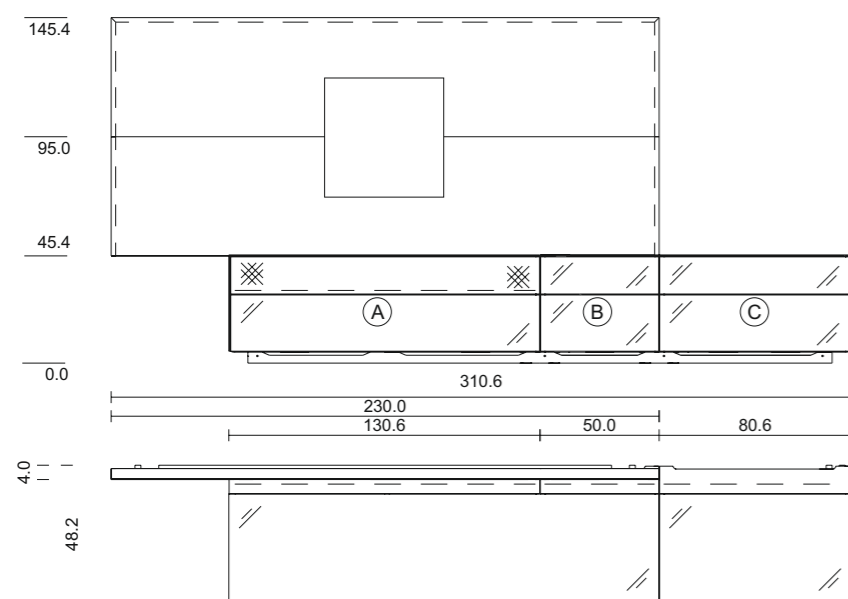

prospetto



tipo di legno: rovere selvatico
vetro: grigio talpa (sinistra), nero (destra)
materiale ribalta altoparlante: tessuto acustico grigio



tipo di legno: ciliegio
vetro: antracite (sinistra), bianco (destra)
materiale ribalta altoparlante: tessuto acustico grigio



tipo di legno: noce
vetro: grigio talpa (sinistra), marrone scuro (destra)
materiale ribalta altoparlante: tessuto acustico nero



tipo di legno: rovere olio bianco
vetro: bronzo (sinistra), marrone scuro (destra)
materiale ribalta altoparlante: tessuto acustico nero



cubus pure parete attrezzata, CPWW 15

TEAM7



cubus pure parete attrezzata, CPWW 15

TEAM7

TEAM7

cabus pure parete attrezzata

CPWW 15

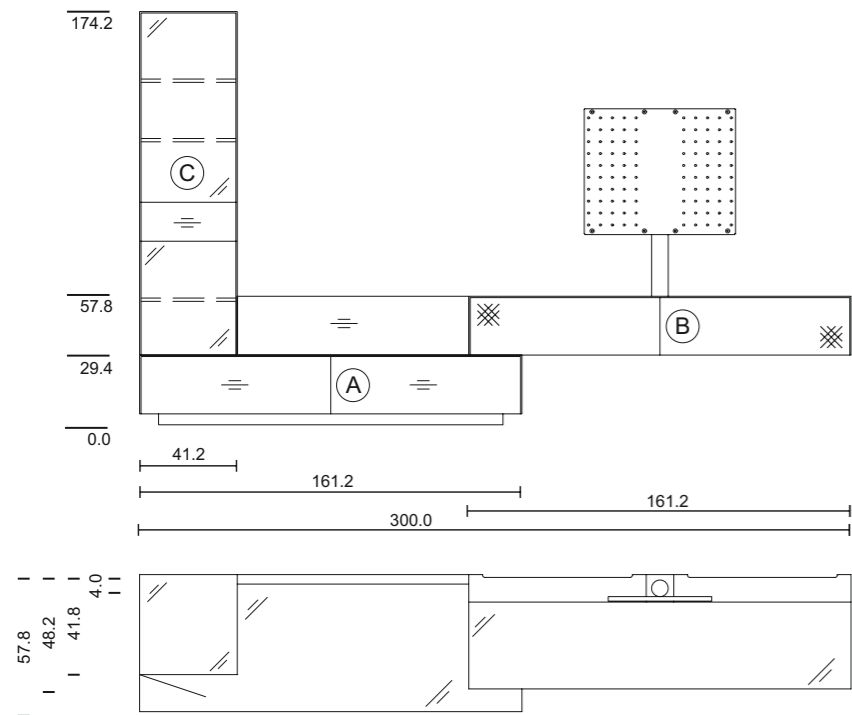

prospetto



tipo di legno: rovere

vetro: bronzo (sinistra sopra), nero (sinistra sotto), grigio talpa (destra)

materiale ribalta altoparlante: tessuto acustico grigio



tipo di legno: faggio selvatico

vetro: sabbia (sinistra sopra), marrone scuro (sinistra sotto), fango (destra)

materiale ribalta altoparlante: tessuto acustico grigio



tipo di legno: ciliegio

vetro: grigio (sinistra sopra), nero (sinistra sotto), bianco (destra)

materiale ribalta altoparlante: tessuto acustico grigio



tipo di legno: noce

vetro: bronzo (sinistra sopra), marrone scuro (sinistra sotto), selce (destra)

materiale ribalta altoparlante: tessuto acustico nero



cubus pure parete attrezzata, CPWW 16

TEAM7



cubus pure parete attrezzata, CPWW 16

TEAM7

TEAM7

cubus pure parete attrezzata

CPWW 16

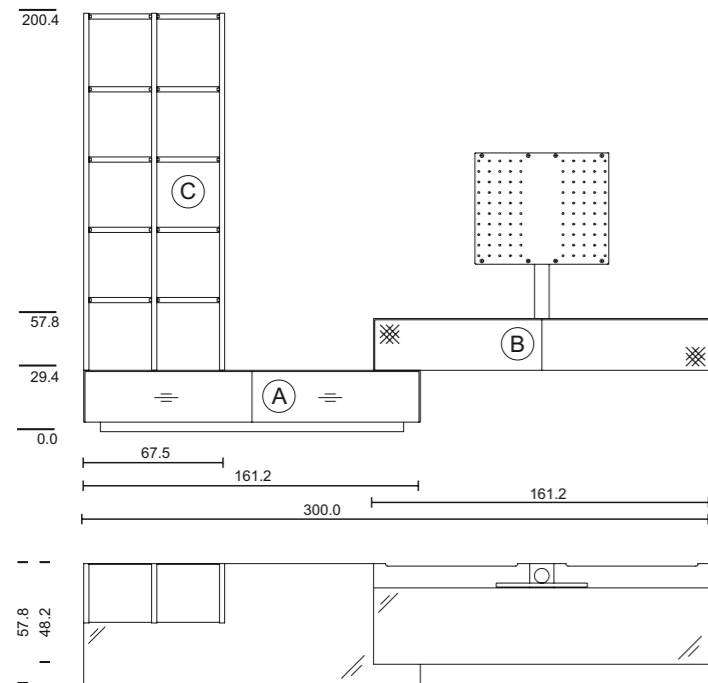

prospetto



tipo di legno: noce

vetro: antracite (sinistra), bianco (destra)

materiale ribalta altoparlante: tessuto acustico nero

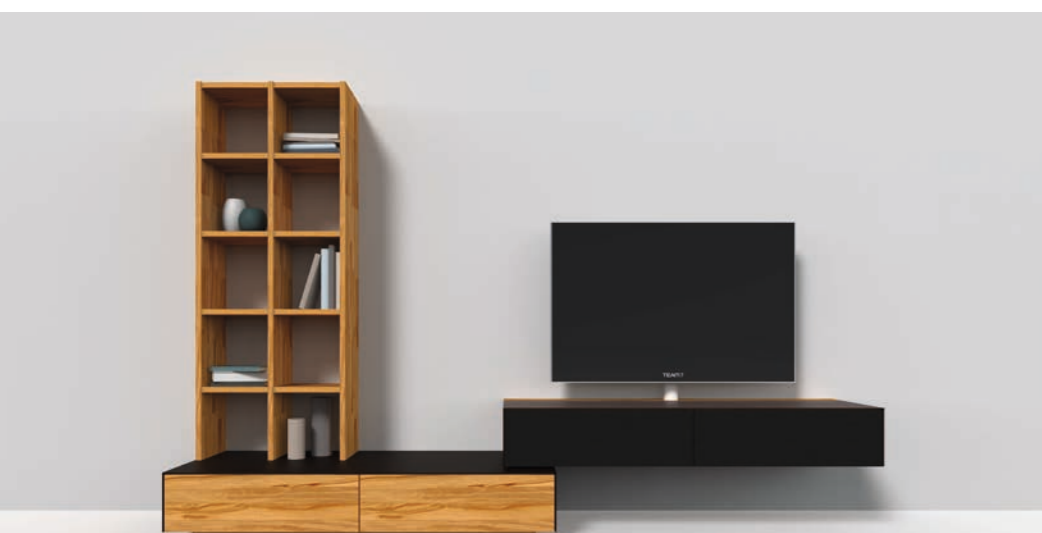

tipo di legno: faggio selvatico

vetro: marrone scuro (sinistra), fango (destra)

materiale ribalta altoparlante: tessuto acustico nero



tipo di legno: rovere

vetro: marrone scuro (sinistra), bronzo (destra)

materiale ribalta altoparlante: tessuto acustico nero

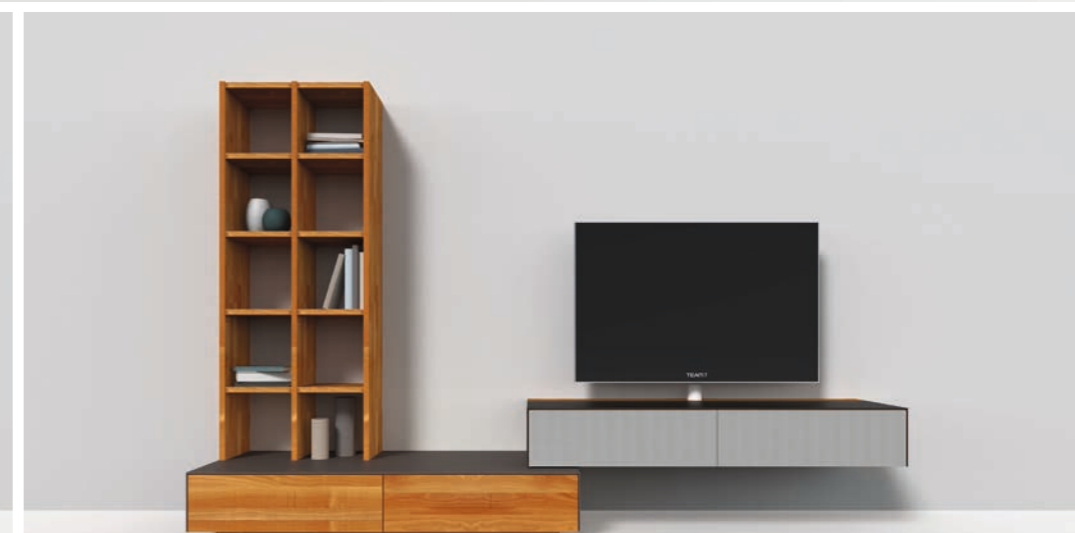

tipo di legno: ciliegio

vetro: grigio talpa (sinistra), marrone scuro (destra)

materiale ribalta altoparlante: tessuto acustico grigio



cubus pure parete attrezzata, CPWW 17

TEAM7



cubus pure parete attrezzata, CPWW 17

TEAM7

TEAM7

cubus pure parete attrezzata

CPWW 17

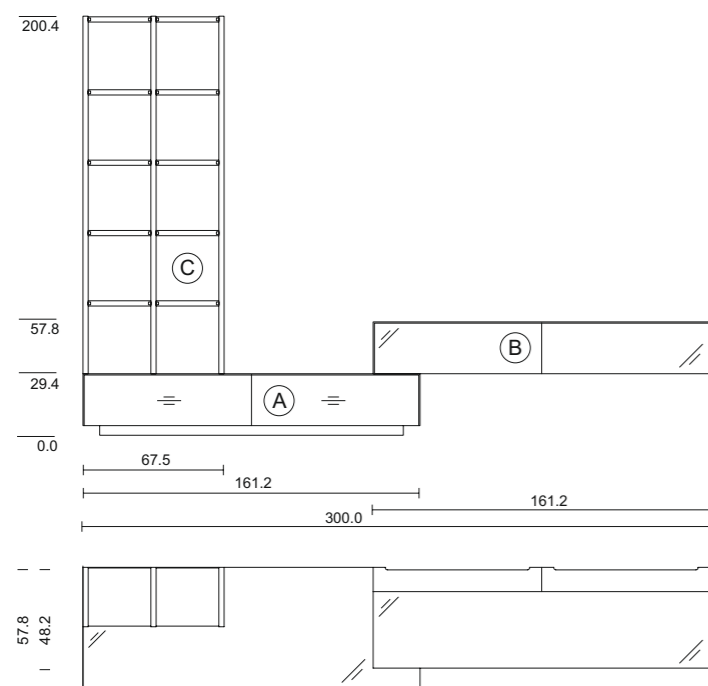

prospetto



tipo di legno: noce
vetro: marrone scuro (sinistra), bronzo (destra)



tipo di legno: ontano
vetro: marrone scuro (sinistra), grigio talpa (destra)



tipo di legno: faggio selvatico
vetro: nero (sinistra), antracite (destra)



tipo di legno: rovere
vetro: nero (sinistra), grigio (destra)



cubus pure parete attrezzata, CPWW 18

TEAM7



cubus pure parete attrezzata, CPWW 18

TEAM7

TEAM7

cubus pure parete attrezzata

CPWW 18

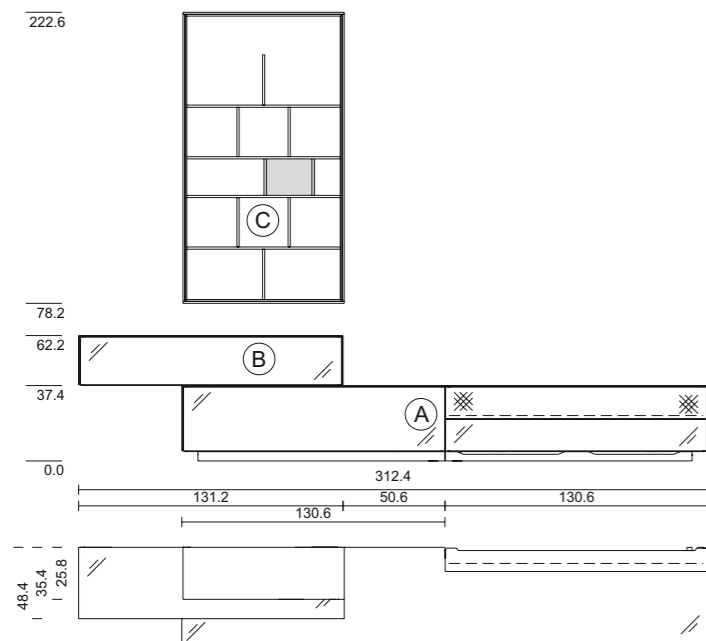

prospetto



tipo di legno: noce

vetro: bronzo (elemento di design, sotto), nero (sinistra)

divisorio in pelle: marrone scuro

materiale ribalta altoparlante: tessuto acustico nero

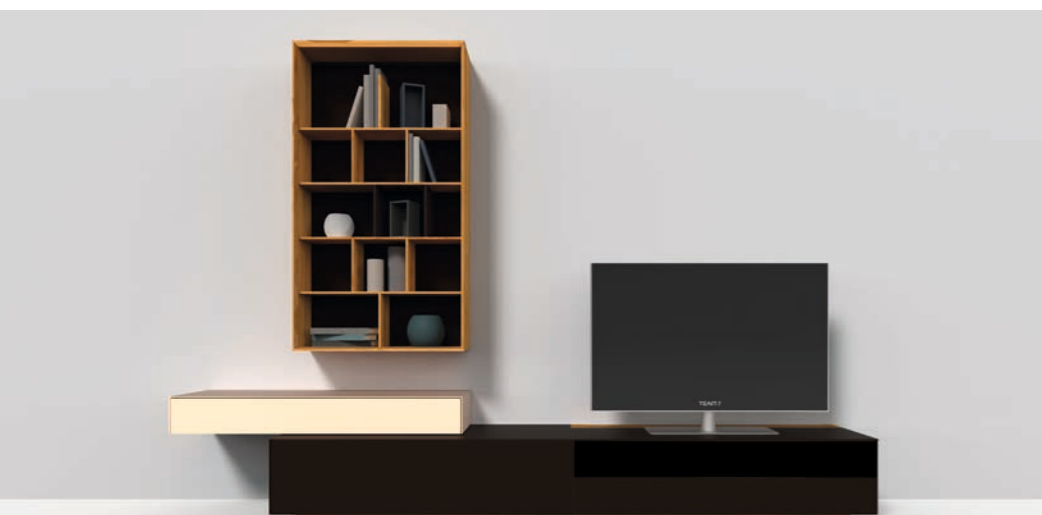

tipo di legno: faggio selvatico

vetro: marrone scuro (elemento di design, sotto), sabbia (sinistra)

divisorio in pelle: marrone scuro

materiale ribalta altoparlante: tessuto acustico nero



tipo di legno: rovere

vetro: antracite (elemento di design, sotto), bianco (sinistra)

divisorio in pelle: antracite

materiale ribalta altoparlante: tessuto acustico grigio



tipo di legno: ciliegio

vetro: selce (elemento di design, sotto), marrone scuro (sinistra)

divisorio in pelle: marrone scuro

materiale ribalta altoparlante: tessuto acustico nero



cubus pure parete attrezzata, CPWW 19

TEAM7



cubus pure parete attrezzata, CPWW 19

TEAM7

TEAM7

cabus pure parete attrezzata

CPWW 19

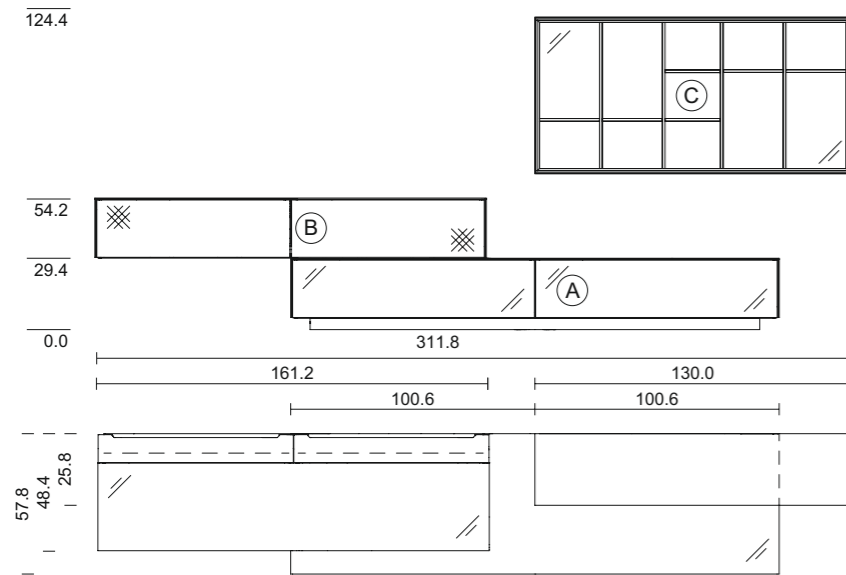

prospetto



tipo di legno: rovere

vetro: grigio talpa (elemento di design, sinistra sopra), marrone scuro (sotto)

materiale ribalta altoparlante: tessuto acustico grigio



tipo di legno: ontano

vetro: bianco (elemento di design, sinistra sopra), antracite (sotto)

materiale ribalta altoparlante: tessuto acustico nero



tipo di legno: faggio selvatico

vetro: fango (elemento di design, sinistra sopra), nero (sotto)

materiale ribalta altoparlante: tessuto acustico nero



tipo di legno: noce

vetro: bianco (sinistra sopra), grigio (elemento di design, sotto)

materiale ribalta altoparlante: tessuto acustico grigio



cubus pure parete attrezzata, CPWW 20

TEAM7



cubus pure parete attrezzata, CPWW 20

TEAM7

TEAM7

cabus pure parete attrezzata

CPWW 20

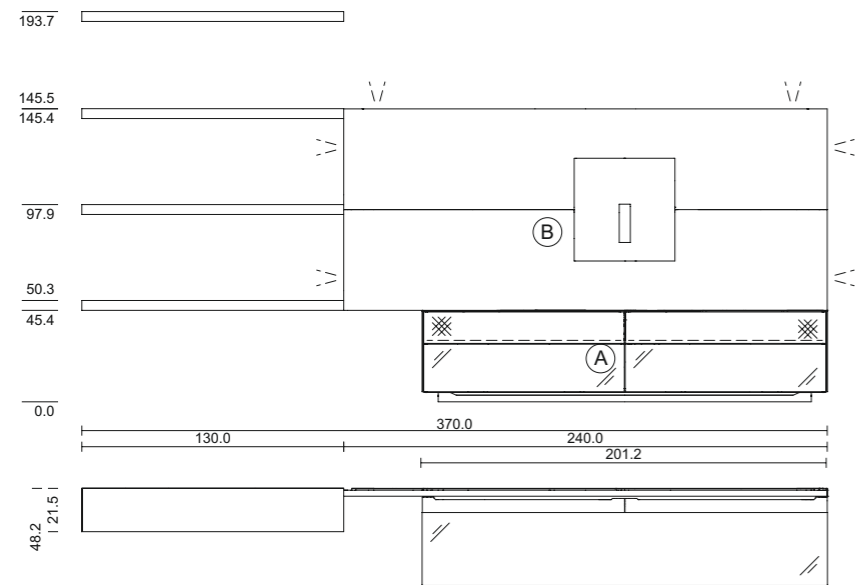

prospetto



tipo di legno: noce selvatico
vetro: selce
materiale ribalta altoparlante: tessuto acustico nero



tipo di legno: faggio selvatico
vetro: grigio
materiale ribalta altoparlante: tessuto acustico grigio



tipo di legno: rovere
vetro: nero
materiale ribalta altoparlante: tessuto acustico grigio



tipo di legno: ciliegio
vetro: bianco
materiale ribalta altoparlante: tessuto acustico nero



cubus pure parete attrezzata, CPWW 22

TEAM7



cubus pure parete attrezzata, CPWW 22

TEAM7

TEAM7

cube pure parete attrezzata

CPWW 22

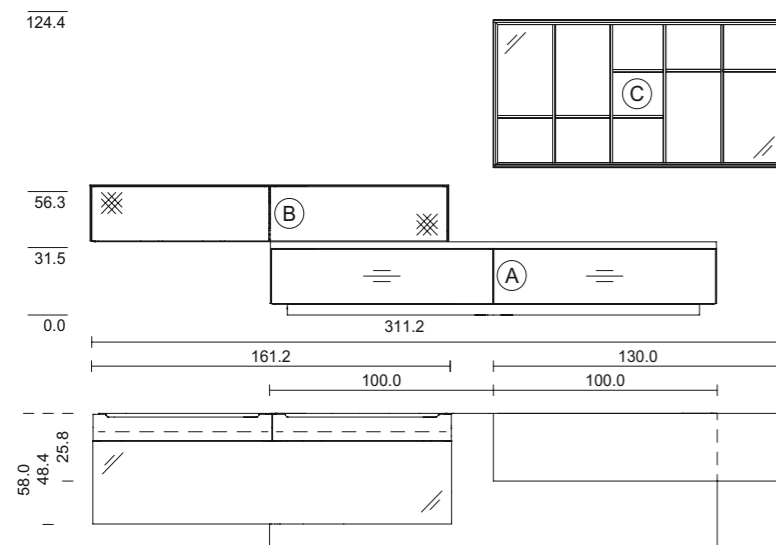

prospetto



tipo di legno: rovere olio bianco
vetro: bianco
materiale ribalta altoparlante: tessuto acustico grigio



tipo di legno: ontano
vetro: sabbia
materiale ribalta altoparlante: tessuto acustico nero

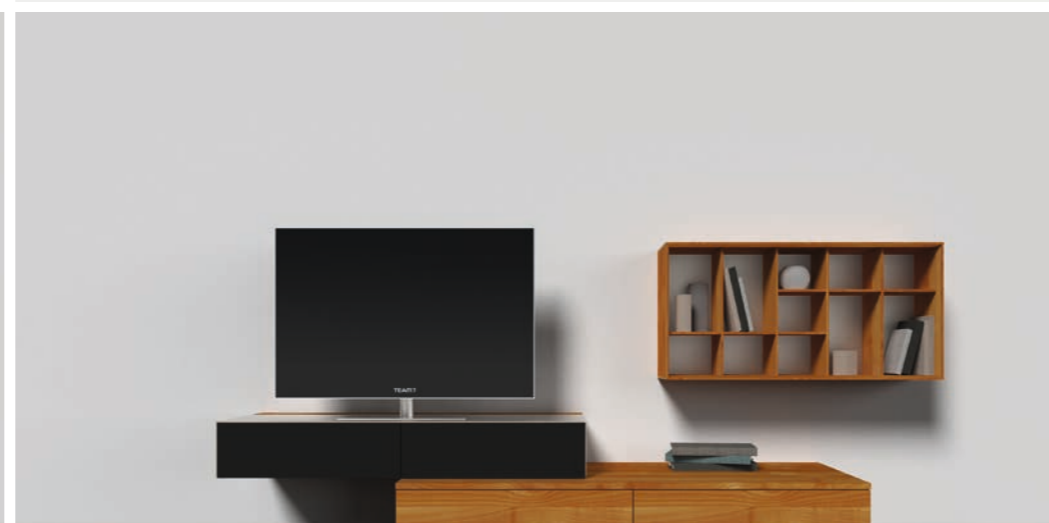

tipo di legno: faggio selvatico
vetro: pearl
materiale ribalta altoparlante: tessuto acustico nero



tipo di legno: noce
vetro: bronzo
materiale ribalta altoparlante: tessuto acustico nero



cubus pure parete attrezzata, CPWW 23

TEAM7



cubus pure parete attrezzata, CPWW 23

TEAM7

TEAM7

cubus pure parete attrezzata

CPWW 23

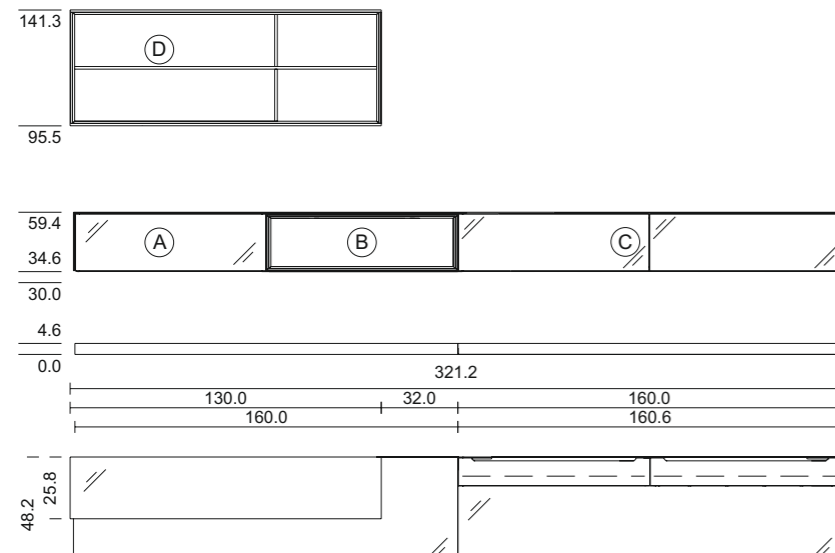

prospetto



tipo di legno: rovere olio bianco
vetro: bianco (elemento di design), grigio talpa (sotto)



tipo di legno: faggio selvatico
vetro: marrone scuro (elemento di design), fango (sotto)



tipo di legno: ciliegio
vetro: grigio (elemento di design), nero (sotto)



tipo di legno: noce
vetro: antracite (elemento di design), grigio (sotto)



cubus pure parete attrezzata, CPWW 24

TEAM7



cubus pure parete attrezzata, CPWW 24

TEAM7

TEAM7

cabus pure parete attrezzata

CPWW 24

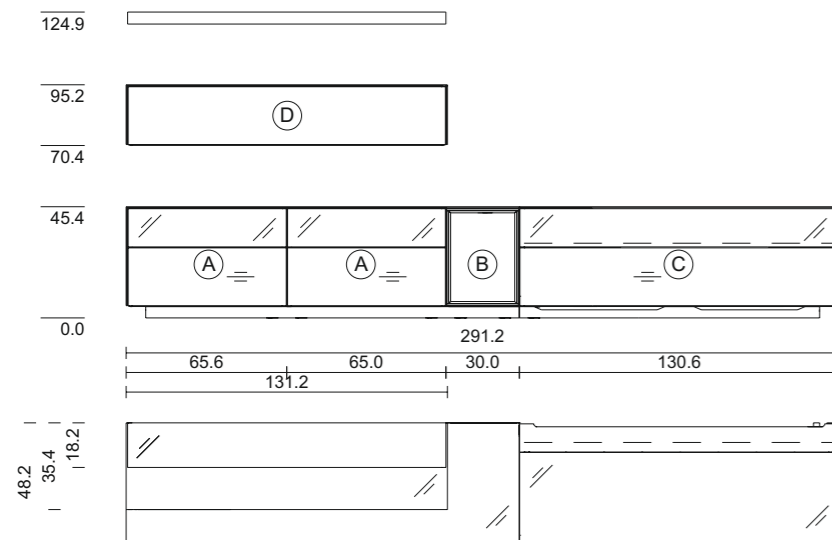

prospetto



tipo di legno: rovere veneziano
vetro: sabbia



tipo di legno: faggio selvatico
vetro: bronzo

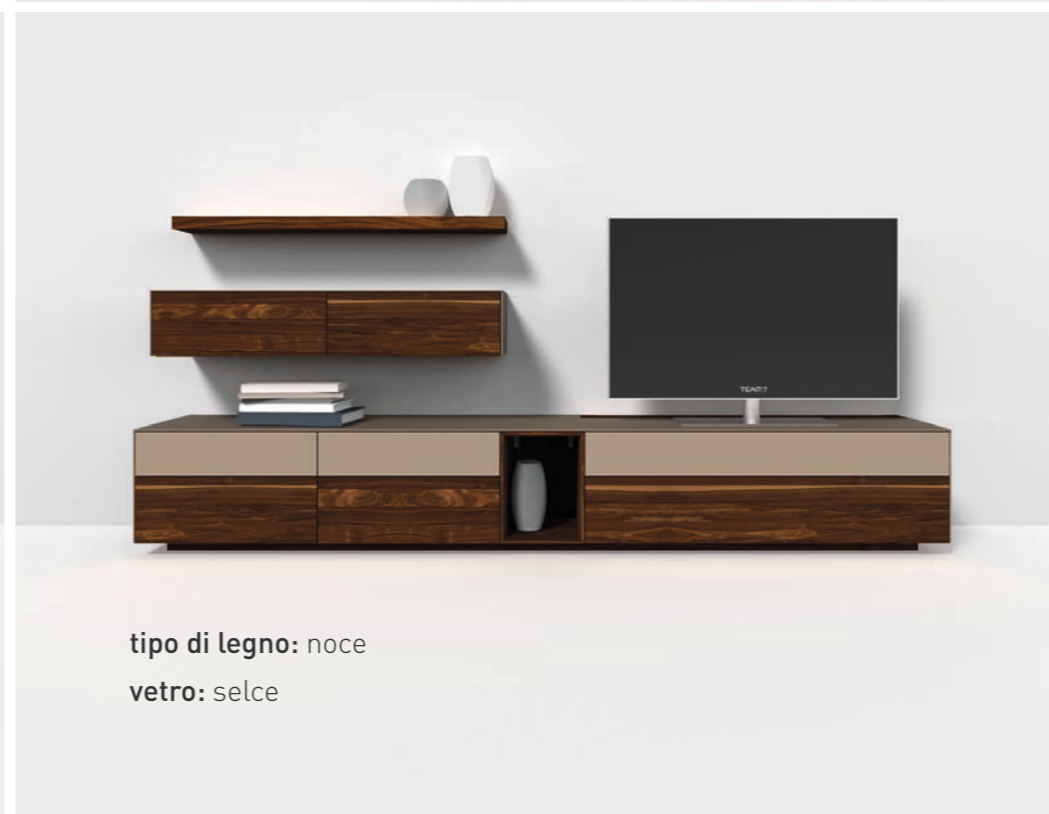

tipo di legno: noce
vetro: selce

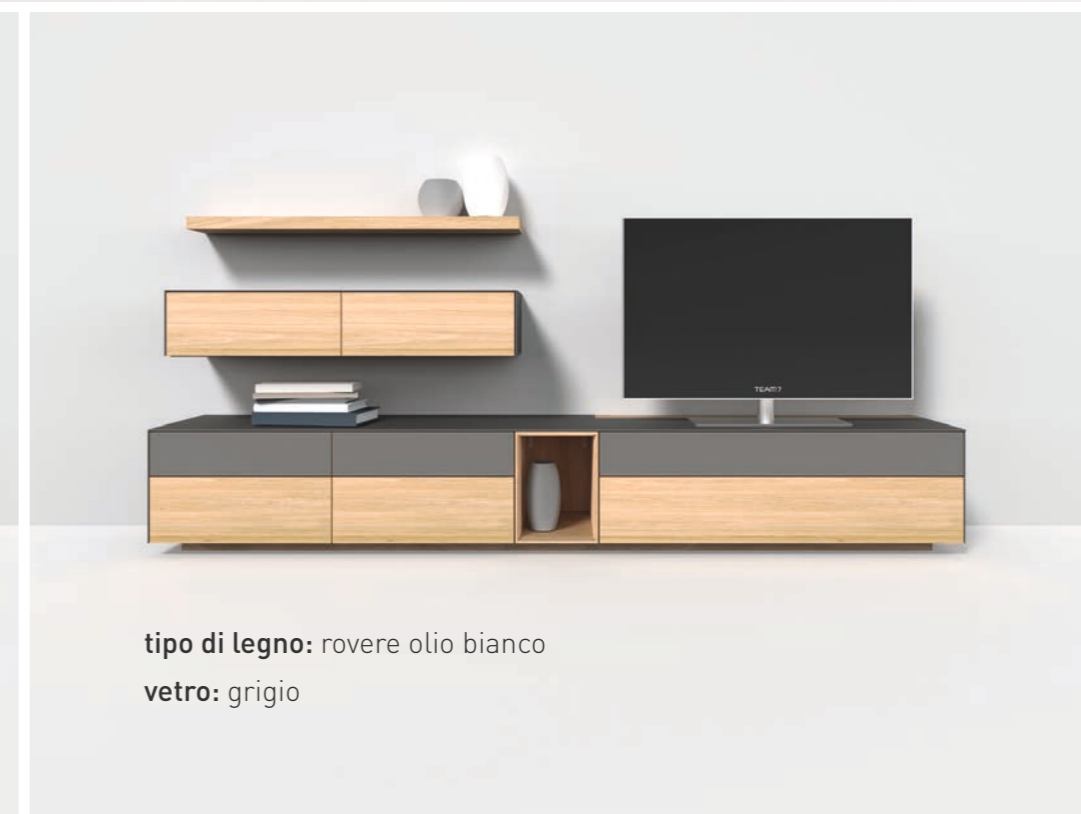

tipo di legno: rovere olio bianco
vetro: grigio



cubus pure parete attrezzata, CPWW 24 A

TEAM7



cubus pure parete attrezzata, CPWW 24 A

TEAM7

TEAM7

cube pure parete attrezzata

CPWW 24 A

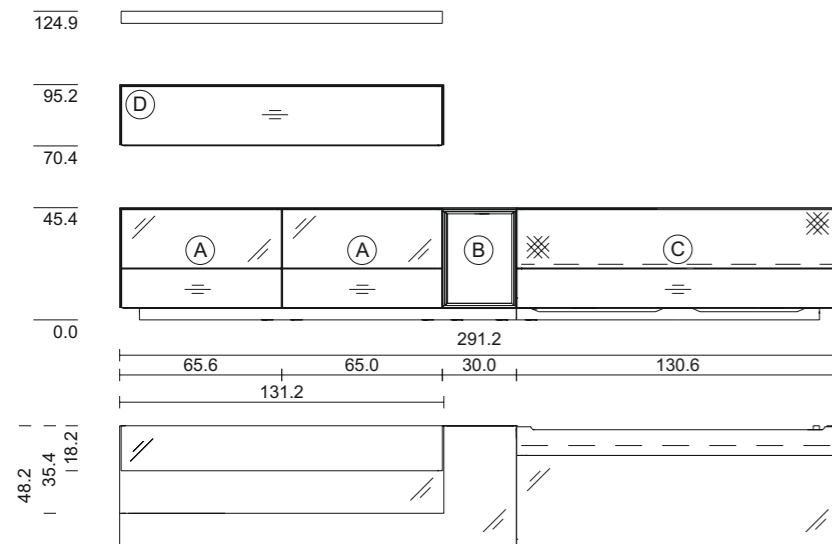

prospetto



tipo di legno: noce
vetro: pearl
materiale ribalta altoparlante: tessuto acustico nero



tipo di legno: ontano
vetro: bianco
materiale ribalta altoparlante: tessuto acustico grigio

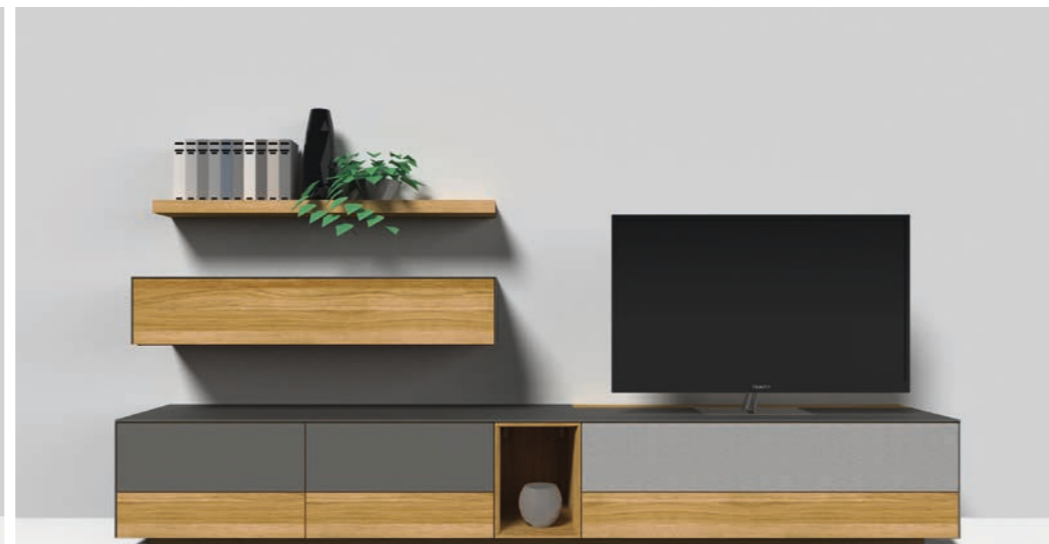

tipo di legno: rovere
vetro: grigio
materiale ribalta altoparlante: tessuto acustico grigio

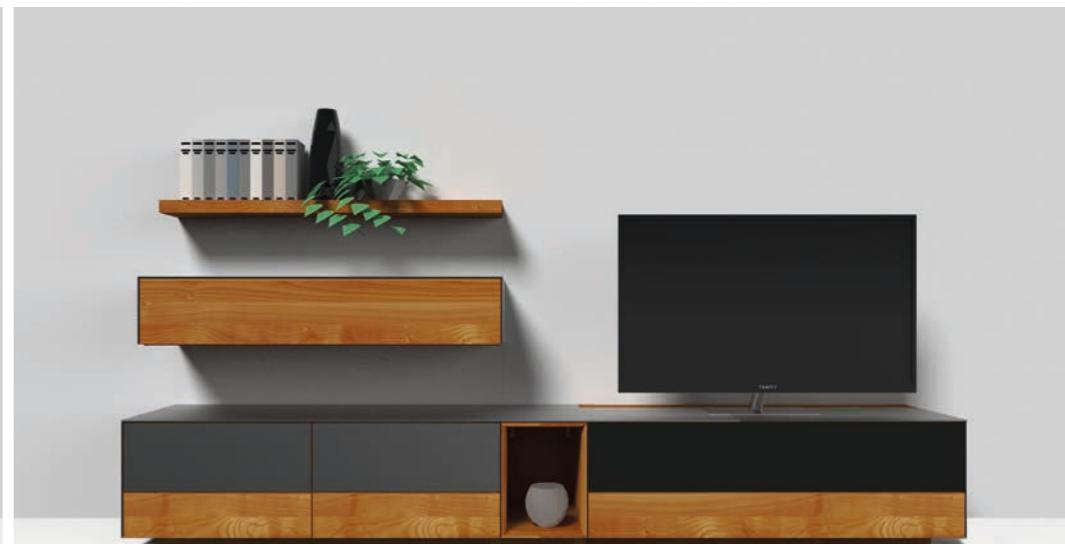

tipo di legno: ciliegio
vetro: acciaio
materiale ribalta altoparlante: tessuto acustico nero



cubus pure parete attrezzata, CPWW 25

TEAM7



cubus pure parete attrezzata, CPWW 25

TEAM7

TEAM7

cabus pure parete attrezzata

CPWW 25

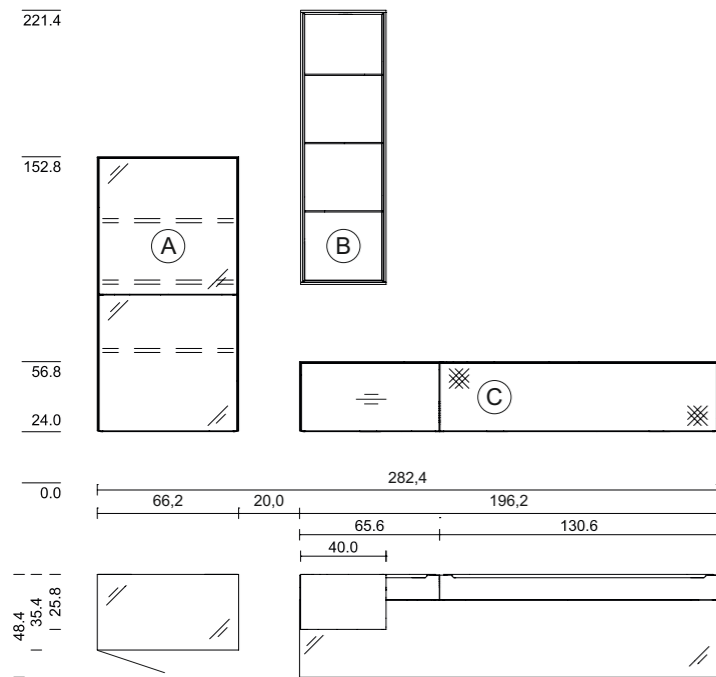

prospetto



tipo di legno: noce
vetro: acciaio
materiale ribalta altoparlante: tessuto acustico nero



tipo di legno: faggio selvatico
vetro: pearl
materiale ribalta altoparlante: tessuto acustico nero



tipo di legno: rovere
vetro: bronzo
materiale ribalta altoparlante: tessuto acustico nero



tipo di legno: kersenhout
vetro: acciaio
materiale ribalta altoparlante: tessuto acustico nero



cubus pure parete attrezzata, CPWW 25 A

TEAM7



cubus pure parete attrezzata, CPWW 25 A

TEAM7

TEAM7

cubus pure parete attrezzata

CPWW 25 A

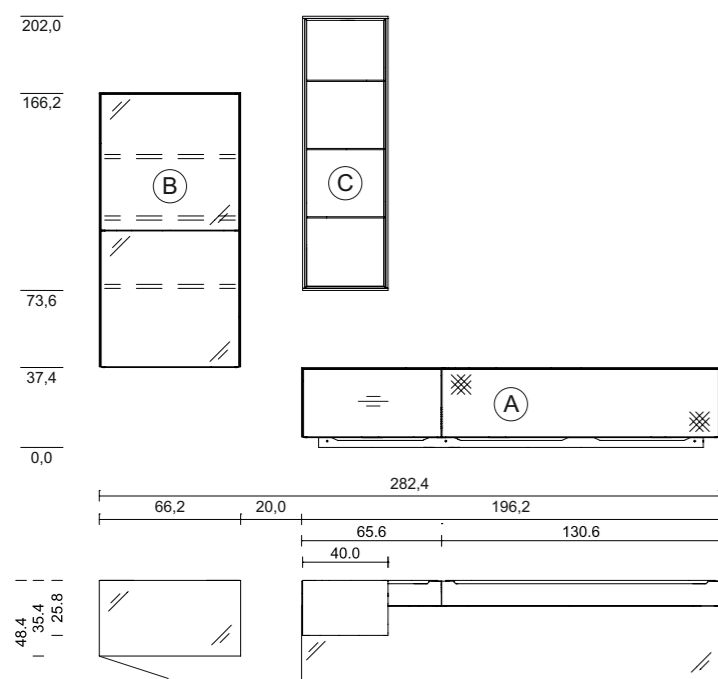

prospetto



tipo di legno: rovere olio bianco
vetro: pearl
materiale ribalta altoparlante: tessuto acustico nero



tipo di legno: ontano
vetro: bianco
materiale ribalta altoparlante: tessuto acustico nero

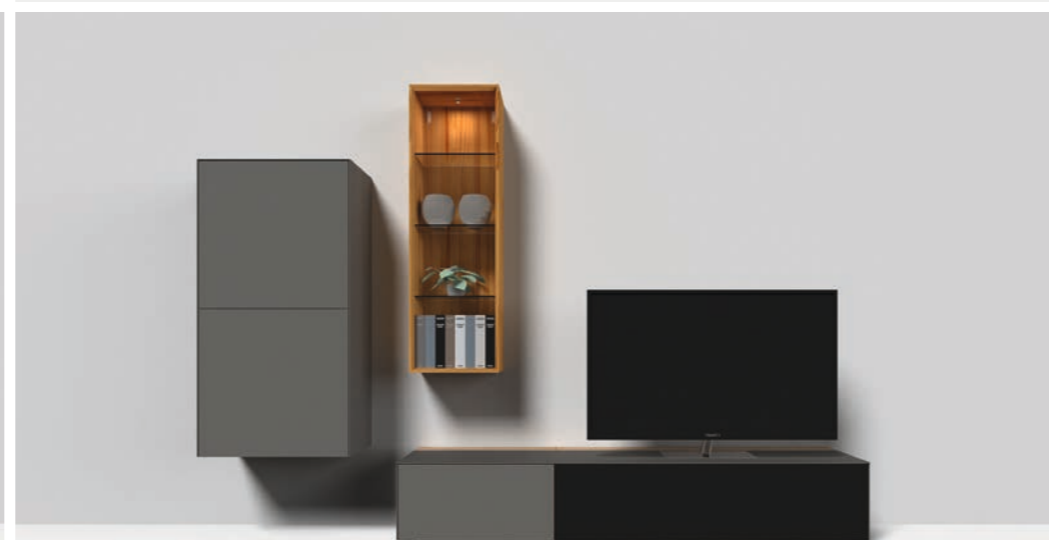

tipo di legno: faggio selvatico
vetro: grigio
materiale ribalta altoparlante: tessuto acustico nero

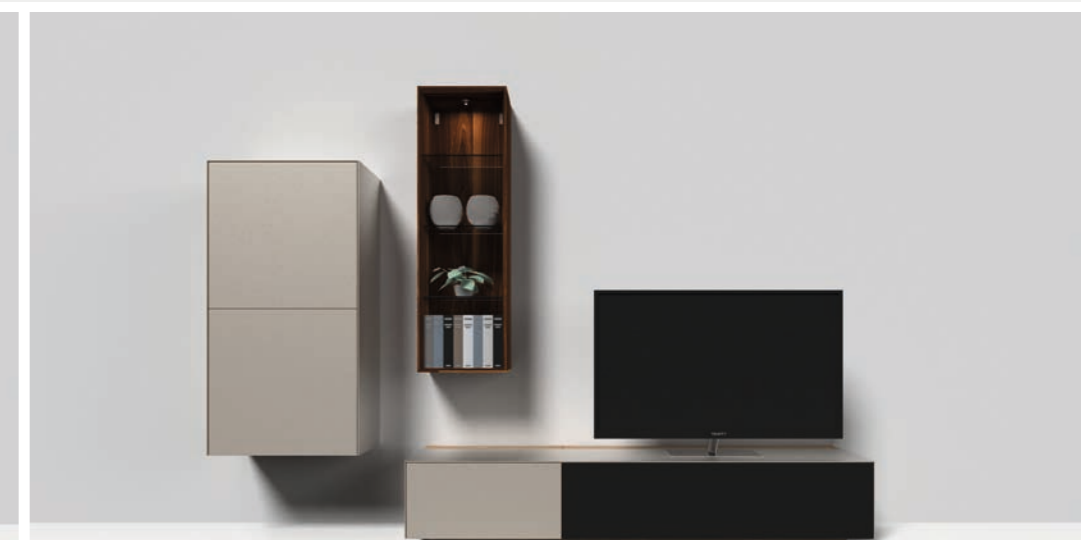

tipo di legno: noce
vetro: pearl
materiale ribalta altoparlante: tessuto acustico nero



cubus pure parete attrezzata, CPWW 26

TEAM7



cubus pure parete attrezzata, CPWW 26

TEAM7

TEAM7

cubus pure parete attrezzata

CPWW 26

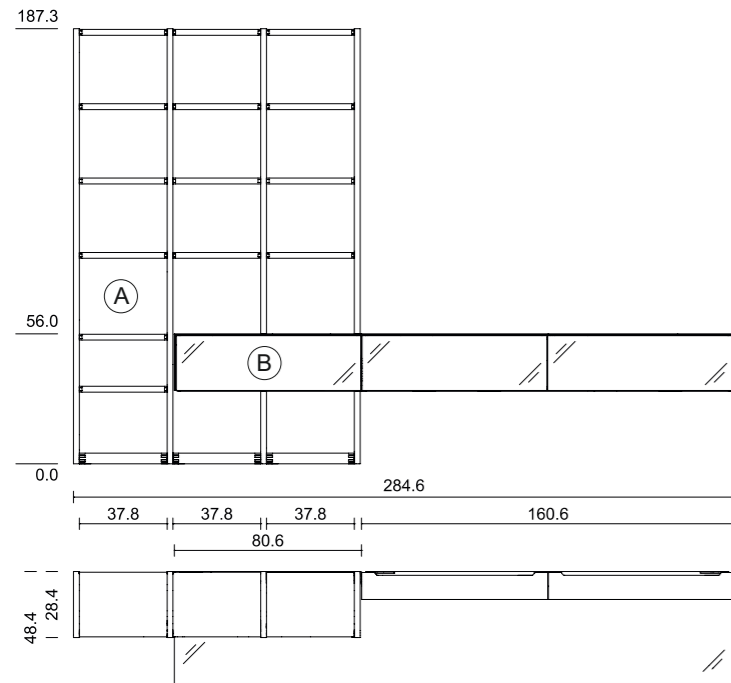

prospetto



tipo di legno: rovere olio bianco
vetro: pearl



tipo di legno: ontano
vetro: marrone scuro



tipo di legno: faggio selvatico
vetro: bianco



tipo di legno: noce
vetro: grigio talpa



cubus pure parete attrezzata, CPWW 27

TEAM7



cubus pure parete attrezzata, CPWW 27

TEAM7

TEAM7

cabus pure parete attrezzata

CPWW 27

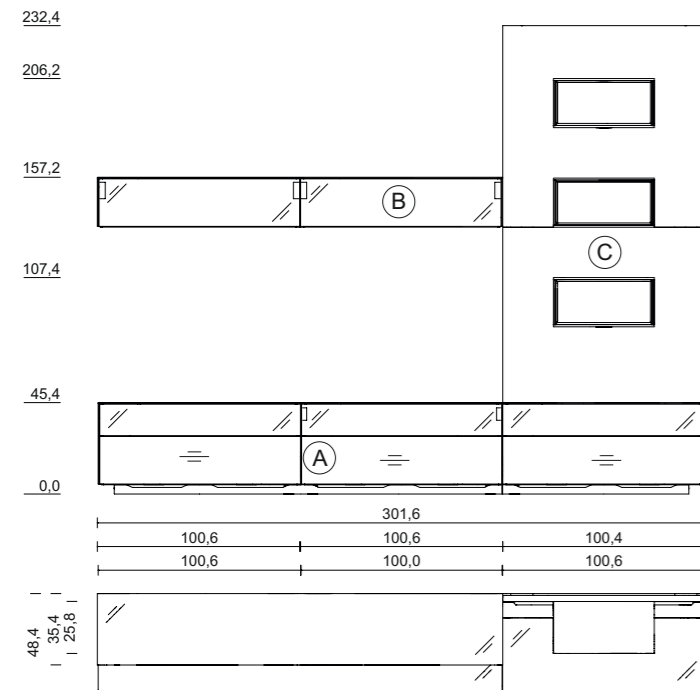

prospetto



tipo di legno: rovere olio bianco
vetro: grigio



tipo di legno: faggio selvatico
vetro: fango



tipo di legno: ciliegio
vetro: acciaio



tipo di legno: noce
vetro: pearl



cubus pure parete attrezzata, CPWW 28

TEAM7



cubus pure parete attrezzata, CPWW 28

TEAM7

TEAM7

cubus pure parete attrezzata

CPWW 28

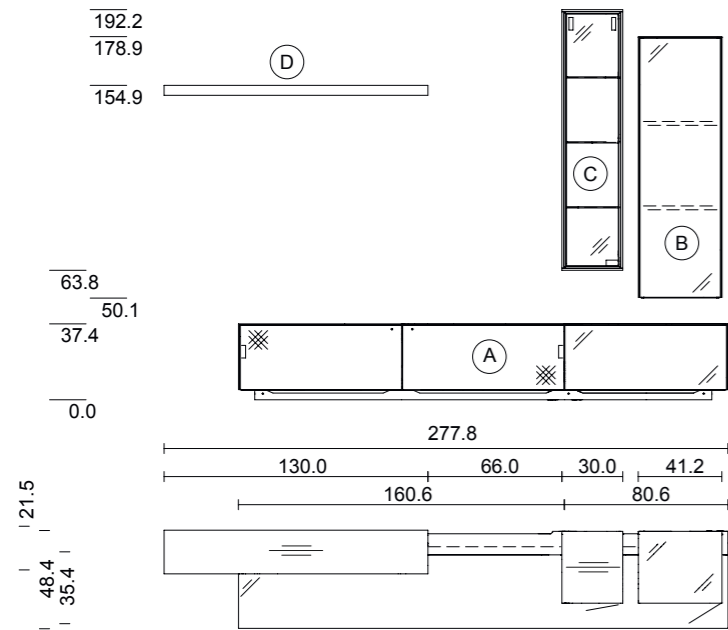

prospetto



tipo di legno: rovere

vetro: bianco

tessuto ribalta altoparlanti: tessuto acustico grigio chiaro



tipo di legno: noce

vetro: grigio

tessuto ribalta altoparlanti: tessuto acustico nero



tipo di legno: faggio selvatico

vetro: sabbia

tessuto ribalta altoparlanti: tessuto acustico nero



tipo di legno: ciliegio

vetro: antracite

tessuto ribalta altoparlanti: tessuto acustico nero



cubus pure parete attrezzata, CPWW 30

TEAM7



cubus pure parete attrezzata, CPWW 30

TEAM7

TEAM7

cube pure parete attrezzata

CPWW 30

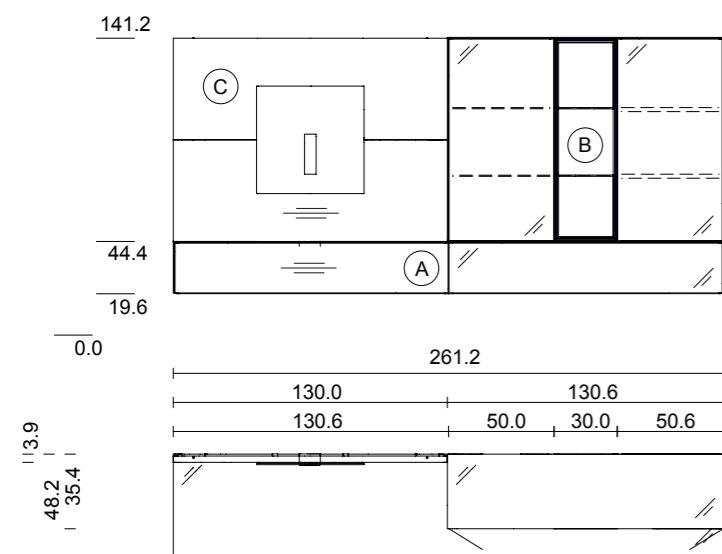

prospetto



tipo di legno: faggio selvatico
vetro: antracite



tipo di legno: noce
vetro: selce



tipo di legno: rovere
vetro: acciaio



tipo di legno: ontano
vetro: bianco



cubus pure parete attrezzata, CPWW 31

TEAM7



cubus pure parete attrezzata, CPWW 31

TEAM7

TEAM7

cabus pure parete attrezzata

CPWW 31

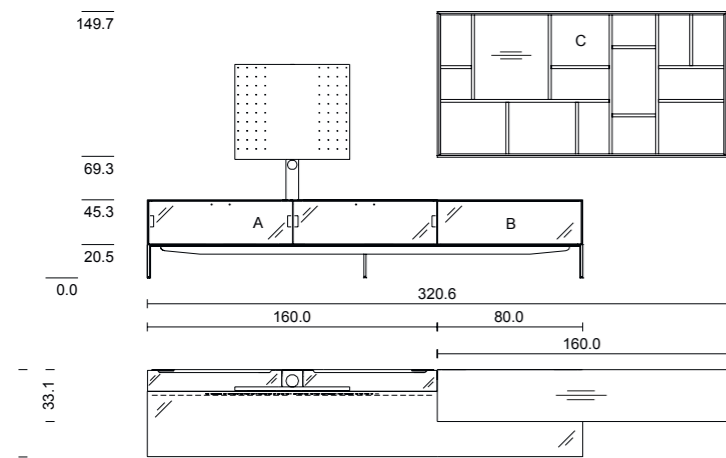

prospetto



tipo di legno: noce
vetro: bianco
base in metallo: bianco neve



tipo di legno: rovere oilio bianco
vetro: grigio
base in metallo: grigio pietra



tipo di legno: noce
vetro: grigio talpa
base in metallo: blu notte



tipo di legno: rovere
vetro: bronzo
base in metallo: marrone terra

TEAM 7 Natürlich Wohnen GmbH

| | |
|------------------------|---|
| Austria | 4910 Ried/Innkreis, Braunauer Straße 26 |
| Svizzera/Italia | 5643 Sins/AG, Tschampani 30 |
| telefono | +43 7752 977-700 |
| e-mail | info@team7.at |
| internet | www.team7.at |

TEAM 7